



Light is motion

Light range 2022/2023

Insist on OSRAM – the No. 1 in Automotive Lighting

Light is OSRAM

OSRAM

Quite simply the best solution

OSRAM provides the perfect vehicle lamp for every use and every requirement, be it in cars, motorcycles, trucks or off-road, be it LED, xenon or halogen, and whether for performance or design-oriented drivers.

Category	Page
OSRAM Trust Program	04
Portfolio overview LED	05
Portfolio overview xenon	07
Portfolio overview halogen	07
Portfolio overview off-road	09
LED lamps	
■ NIGHT BREAKER® LED	10
■ LEDriving® HL ²⁾	12
■ LEDriving® FL ²⁾	14
■ LEDriving® SL ²⁾	14
■ LEDriving® HLM ²⁾	15
■ LEDriving® HLT 24V ²⁾	16
■ LEDriving® Accessories	16
Xenon	
■ XENARC® NIGHT BREAKER® LASER (NEXT GEN)	18
■ XENARC® COOL BLUE® INTENSE (NEXT GEN)	19
■ XENARC® ULTRA LIFE	19
■ XENARC® ORIGINAL	20
Halogen car	
■ NIGHT BREAKER® 200	21
■ NIGHT BREAKER® LASER	22
■ NIGHT BREAKER® SILVER	22
■ COOL BLUE® INTENSE (NEXT GEN)	23
■ DIADEM® CHROME	24
■ ULTRA LIFE	24
■ ORIGINAL LINE 12V	25
■ MINIBOX	28
Halogen truck	
■ TRUCKSTAR® PRO	29
■ ORIGINAL LINE 24V	30
■ Spare lamp kit 24V	31
Halogen motorcycle	
■ ORIGINAL	32
Off-road	
■ SUPER BRIGHT PREMIUM ²⁾	
■ SUPER BRIGHT ²⁾	33
■ XENARC® COOL BLUE® BOOST ²⁾	
■ COOL BLUE® BOOST ²⁾	34

Category	Page
LED fixtures	
■ LEDriving® headlights	35
■ LEDriving® XENARC® headlights	37
■ LEDriving® universal headlights	39
■ LEDriving® dynamic mirror indicator	40
■ LEDriving® tail lights	42
■ LEDriving® driving lights	44
■ LEDriving® working lights	46
■ LEDriving® daytime running lights	47
■ LEDambient® ²⁾	48
Tools	
Automotive lamp cabinet and MINIWATT® assortment box	49
Measurements	50
Bases	58
Index	60
Summary of types and applications	74
Order information	82

■ = INNOVATION ■ = PERFORMANCE ■ = DESIGN ■ = COMFORT ■ = ORIGINAL

- 1) Please note: This catalogue contains an international portfolio. Several countries do not allow sale and use of non-ECE approved products. Please contact your local distributor for information on the availability in your country.
- 2) These products do not have ECE approval and must not be used on public roads in any exterior application. Public roads use leads to cancellation of operating license and loss of insurance coverage. Several countries forbid sale and use of these products. Please contact your local distributor for further information.

All OSRAM 12 V and 24 V halogen automotive lamps are UV-reduced, can replace existing lamps and meet the relevant standards, e.g. ECE R37 (with the exception of OFF-ROAD lamps)



The OSRAM Trust Program

Verify genuine lamps. Ensure OSRAM quality.

Installing counterfeit lamps in a vehicle can have serious consequences. These products may not only impact the safety of road users but can also damage parts of the car or motorcycle.



How to verify original OSRAM lamps



How to check your lamps

Online checking tool

Visit osram.com/trust or scan the QR code on your product using a smartphone or tablet device, and take the following steps:

- 1 Enter the **7-digit label code** which can be found on every genuine OSRAM xenon packaging, halogen DUO BOX or NIGHT BREAKER® LED packing. This will be auto-filled when using the QR code on the label.



- 2 Next, you will be asked whether the automatically prompted lamp data matches either the **unique lamp code**, on the base of your xenon and NIGHT BREAKER® LED lamps OR **the product family and OSRAM order no** on your halogen DUO BOX.



The moment of truth

Please decide whether the data matches or not. Use either the “Yes” or “No” button on the page. After doing so, you’ll receive one of three possible outcomes.

Yes → Genuine

Packaging is authenticated and lamp data is correct.

→ You have purchased original OSRAM lamps

Possible issues

Packaging is authenticated but the label code has been entered too often.

→ Contact OSRAM customer service via trust-com@osram.com

No → No match

Invalid label code or the prompted lamp data doesn’t match with your product(s).

→ Contact your dealer or OSRAM customer service

Portfolio overview LED

INNOVATION / LED RETROFITS	
	<p>NIGHT BREAKER® LED¹⁾ First street legal H4-LED and H7-LED in low beam and high beam approved for respective countries</p> <p>Range P43t (H4), PX26d (H7)</p> <p>>> Page 10</p>
	<p>LEDDriving® HL²⁾ LED high and low beam lamps – cool look and great visibility</p> <p>LEDDriving® HL EASY >> Page 12</p> <p>LEDDriving® HL BRIGHT >> Page 12</p> <p>LEDDriving® HL INTENSE >> Page 12</p> <p>Range P43t/PU43t-3 (H4/H19), PX26d/PY26d-1 (H7/H18), PGJ23t-1 (H15)</p> <p>Range P14.5s (H1), P43t/PU43t-3 (H4/H19), PX26d/PY26d-1 (H7/H18), PGJ19-X (H8/H11/H16/H9), P20d /PY20d/PX20d (HB3/H10/HIR1), P22d/PX22d (HB4/HIR2), P26.4t(H13)</p> <p>Range P43t/PU43t-3(H4/H19), PX26d/PY26d-1 (H7/H18)</p>
	<p>LEDDriving® FL²⁾ LED fog lamp for maximum visibility – 6,000 K socket solution</p> <p>Range PGJ19 (H8/H11/H16), PY20D (H10), PG20-7 (PSX24W)</p> <p>>> Page 14</p>
	<p>LEDDriving® SL²⁾ LED interior and exterior signal lamps – many bases & colors</p> <p>Range PG18.5D-1 (P13W), PG20-1 (PS19W), W2.1X9.5D (W5W/WY5W, W16W), SV8.5-8 (FESTOON 31 MM, C5W 36 MM, FESTOON 41 MM), BA15S (P21W, R5W, R10W), BAU15S (PY21W), W3X16Q (W21/5W), W3X16D (W21W), WX3X16D (WY21W), BAY15D (P21/5W), W2.5X16Q (P27/7W), BA9S (T4W), W2X4.6D (W2.3W)</p> <p>>> Page 14</p>
	<p>LEDDriving® HLM²⁾ LED high and low beam lamp – cool & easy upgrade for motorcycles</p> <p>Range PX43T (HS1), P15D-25-1 (T19)</p> <p>>> Page 15</p>
	<p>LEDDriving® HLT²⁾ 24V LED high and low beam lamp – easy & efficient upgrade for trucks</p> <p>Range P14.5S (H1), P43T (H4), PX26D (H7)</p> <p>>> Page 16</p>

1-2) Footnotes on page 6

Portfolio overview LED

INNOVATION / LED FIXTURES



LEDDriving® headlights³⁾
LEDDriving® XENARC® headlights³⁾
LEDDriving® universal headlights³⁾
LEDDriving® tail lights³⁾
 High efficiency, high effectiveness – individual look made easy

>> Page 35-39, 42

Range

LEDHHL102, LEDHHL103, LEDHHL104, LEDHHL105, LEDHHL107, LEDHHL108, LEDHHL109, LEDTL101, LEDTL102, LEDUHL101, LEDUHL102, LEDUHL103, LEDUHL104, LEDUHL MOUNT101



LEDDriving® dynamic mirror indicator³⁾
 Individual design meets innovative lighting technology

>> Page 40

Range

LEDDMI 5G0, LEDDMI 5K0, LEDDMI 3G0, LEDDMI F20, LEDDMI 8W0, LEDDMI 5F0, LEDDMI 8V0



LEDDriving® driving lights⁴⁾
 Intense white light – for dark country roads, forest paths etc.

>> Page 44

Range

AX-, FX-, MX-, SX-, VX-SERIES



LEDDriving® working lights²⁾
 Intense white light – for construction sites, forest work etc.

>> Page 46

Range

MX-, PX-SERIES, VX-SERIES



LEDDriving® daytime running lights
 Stylish, easy-to-install light guide and pixel solution

>> Page 47

Range

LG, PX-5

INNOVATION / LED STYLING LIGHTS



LEDambient®
 Interior ambient lighting – high brightness, easy-to-install

>> Page 48

Range

TUNING LIGHTS BASE KIT²⁾, TUNING LIGHTS EXTENSION KIT²⁾, INTERIOR STRIP KIT²⁾

1) Approved LED headlamp. Only applies to the respective countries with approval, vehicle models and light functions currently listed in the compatibility list. For exact conditions see www.osram.com/nb-led

2) These products do not have ECE approval and must not be used on public roads in any exterior application. Public roads use leads to cancellation of operating license and loss of insurance coverage. Several countries forbid sale and use of these products. Please contact your local distributor for further information.

3) Refer to www.osram.com/am for detailed vehicle models

4) Special mounting regulations apply

Portfolio overview xenon

PERFORMANCE



XENARC® NIGHT BREAKER® LASER
Up to +220% BRIGHTNESS¹⁾

Range
D1S, D2S, D3S, D4S

>> [Page 18](#)

DESIGN



XENARC® COOL BLUE® INTENSE
LED white light

Range
D1S, D2S, D2R, D3S, D4S, D8S

>> [Page 19](#)

COMFORT



XENARC® ULTRA LIFE
10-year OSRAM guarantee²⁾

Range
D1S, D2S, D3S, D4S

>> [Page 19](#)

ORIGINAL



XENARC® ORIGINAL
ORIGINAL SPARE PART

Range
D1S, D1R, D2S, D2R, D3S, D3R,
D4S, D4R, D5S, D8S

>> [Page 20](#)

Portfolio overview halogen car

PERFORMANCE



NIGHT BREAKER® 200
Up to +200% BRIGHTNESS³⁾

Range
H4, H7, H11

>> [Page 21](#)



NIGHT BREAKER® LASER
Up to +150% BRIGHTNESS³⁾

Range
H1, H3, H4, H7, H8, H11, HB3, HB4

>> [Page 22](#)

1) Compared to minimum ECE R98 requirements

2) Refer to www.osram.com/am-guarantee for precise conditions

3) Compared to minimum ECE R112 requirements

Portfolio overview halogen car

PERFORMANCE		
	<p>NIGHT BREAKER® SILVER Up to +100% BRIGHTNESS¹⁾</p> <p>>> Page 22</p>	<p>Range H1, H4, H7, H11</p>
DESIGN		
	<p>COOL BLUE® INTENSE LED look</p> <p>>> Page 19</p>	<p>Range H1, H4, H7, H8, H11, H15, HB3, HB4, HIR2, W5W</p>
	<p>DIADEM® CHROME Amber when on</p> <p>>> Page 24</p>	<p>Range WY5W, PY21W</p>
COMFORT		
	<p>ULTRA LIFE 4-year OSRAM guarantee²⁾</p> <p>>> Page 24</p>	<p>Range H1, H4, H7, H11, P21W, PY21W, P21/5W, W5W, R5W, R10W, C5W, H6W, HY21W</p>
ORIGINAL		
	<p>ORIGINAL ORIGINAL SPARE PART</p> <p>>> Page 25</p>	<p>Range Complete Product Range</p>

Portfolio overview halogen truck

PERFORMANCE		
	<p>TRUCKSTAR® PRO Up to +120% BRIGHTNESS¹⁾</p> <p>>> Page 29</p>	<p>Range H1, H3, H4, H7, H11, PY21W, P21W, P21/5W, W5W, R5W, R10W, T4W</p>

1) Compared to minimum ECE R112 requirements
 2) Refer to www.osram.com/am-guarantee for precise conditions

Portfolio overview halogen truck

ORIGINAL



ORIGINAL
ORIGINAL SPARE PART

Range
Complete Product Range

>> Page 30

Portfolio overview motorcycle

ORIGINAL



ORIGINAL
ORIGINAL SPARE PART

Range
S1, S2, HS1

>> Page 32

Portfolio overview off-road

PERFORMANCE



**SUPER BRIGHT/
SUPER BRIGHT PREMIUM¹⁾**
EXTRA POWER

Range
P14.5s (H1), PK22s (H3), P43t (H4),
PX26d (H7), P20d (HB3), P22d (HB4),
PX14.5s, PKY22s, P45t (R2)

>> Page 33

DESIGN



XENARC® COOL BLUE® BOOST¹⁾
LED HYPER WHITE

Range
PK32d-2 (D1S), P32d-2 (D2S),
PK32d-5 (D3S), P32d-5 (D4S)

>> Page 34



COOL BLUE® BOOST¹⁾
LED HYPER LOOK

Range
P14.5s (H1), P43t (H4), PX26d (H7),
PGJ19-2 (H11)

>> Page 34

1) These products do not have ECE approval and must not be used on public roads in any exterior application. Public roads use leads to cancellation of operating license and loss of insurance coverage. Several countries forbid sale and use of these products. Please contact your local distributor for further information.



LEDiving® replacement lamps

Wide range for various applications

The OSRAM LEDiving® RETROFIT portfolio includes LED high and low beam lamps, fog lamps, signal as well as interior lamps with superior brightness and color temperatures of up to 6,000 K.



NIGHT BREAKER® LED¹⁾

OSRAM's first street legal H4-LED and H7-LED in high and low beam application for respective 12V-vehicles as well as H7-LED in low beam for respective 24V-vehicles



Features

- First street legal H4-LED and H7-LED in low beam and high beam for respective 12V-vehicles and H7-LED in low beam for respective 24V-vehicles¹⁾
- Up to 230% more brightness²⁾
- Up to 5 times more lifetime³⁾ and dedicated guarantee⁴⁾
- Compact design, individual car testing approved by official inspection authorities

Benefits

- Better seen and be seen, for more safety on the road
- Cool White LED-Upgrade with color temperature close to daylight for specific car models
- Easy installation with suitable accessories for installation and an affordable alternative compared to full LED systems

OSRAM NIGHT BREAKER® LED¹⁾ product range

Product Reference		Product Number	V	W	K				
64193DWNB	P43t (H4)	4062172 284691	12	27/23	6,000	Cool White	2	4	1 ^{P.50}
64193DWNB-FB	P43t (H4)	4062172 284714	12	27/23	6,000	Cool White	2	4	1 ^{P.50}
64210DWNB	PX26d (H7)	4062172 155045	12/24	19	6,000	Cool White	2	4	2 ^{P.50}
64210DWNB-FB	PX26d (H7)	4062172 254779	12/24	19	6,000	Cool White	2	4	2 ^{P.50}



The **LEDDriving® SMART CANBUS** serves as a bypass of a vehicle's lamp failure detection system when using a H7-LED retrofit lamp. The control unit offers an easy installation and is suitable for most vehicle models with automatic lamp failure detection system. One additional feature is the flickering-free in the vehicle's headlamp. OSRAM provides a 3 year guarantee for this product. For precise conditions refer to www.osram.com/am-guarantee.



Features

- Flicker-free
- 3-year OSRAM guarantee⁴⁾

Benefits

- Prevent error messages in bord computers prompted by H7-LED lamps
- OSRAM quality for more customer satisfaction
- Suitable for most vehicle models with automatic lamp failure detection system

OSRAM LEDDriving® SMART CANBUS and ERROR CANCELER product range (for H7-LED)⁵⁾

Product Reference	Product Number	V	W	K	COLOR			No.	
LEDSC01-2HFB ⁶⁾	4062172176439	12	12	-	-	2	4	6 ^{P.54}	
LEDSC02-1-2HFB ⁷⁾	4062172176460	12	16	-	-	2	4	7 ^{P.54}	
LEDSC03-2HFB ⁷⁾	4062172176491	12	12	-	-	2	4	8 ^{P.54}	
LEDSC03-1-2HFB ⁷⁾	4062172278249	12	12	-	-	2	4	9 ^{P.54}	
Error canceler									
LEDEC01-2HFB ⁶⁾	4062172293945	12	>1	-	-	2	4	-	

LEDDriving® CAP are designed to enable the installation of the H7-LED to have an accurate fit and to protect the headlight system. These products are a replacement of the original cap to offer a qualitative system component for the legal usage.



Features

- Enables the installation of the H7-LED
- Replacement of original cap in OSRAM quality

Benefits

- Mechanical fit and protects headlight system
- System component for H7-LED installation

OSRAM LEDDriving® CAP product range (for H7-LED)

Product Reference	Product Number	V	W	K	COLOR			No.
LEDCAP01	4062172241878	-	-	-	-	2	8	10 ^{P.54}
LEDCAP02	4062172241908	-	-	-	-	2	8	11 ^{P.54}
LEDCAP03	4062172271394	-	-	-	-	2	8	12 ^{P.54}
LEDCAP04	4062172278560	-	-	-	-	2	8	13 ^{P.54}
LEDCAP06	4062172305952	-	-	-	-	2	8	-
LEDCAP07	4062172305983	-	-	-	-	2	8	-
LEDCAP08	4062172309509	-	-	-	-	2	8	-
LEDCAP09	4062172309530	-	-	-	-	2	8	-
LEDCAP10	4062172325912	-	-	-	-	2	8	-
LEDCAP11	4062172325981	-	-	-	-	2	8	-
LEDCAP12	4062172326070	-	-	-	-	2	8	-

Coming soon

1) Approved LED headlamp. Only applies to the respective countries with approval, vehicle models and light functions currently listed in the compatibility list. For exact conditions see www.osram.com/nb-led | 2) Compared to minimum ECE R112. On top with 50% less glare.

3) Compared to halogen lamps | 4) Refer to www.osram.com/am-guarantee for precise conditions | 5) LEDDriving® SMART CANBUS (P.16) avoids error messages on the bord computer when using LED lamps | 6) General connector 7) Car specific connector



The mounting brackets offer an easy installation and compatibility for a variety of cars. Compatibility can be checked on the OSRAM website. Only the combination of OSRAM NIGHT BREAKER® LED lamps in connection with the official OSRAM accessories – LEDriving® ADAPTER and LEDriving® SMART CANBUS (where required) – is permitted.



Features

- Fits for H7-LED
- Fixes H7-LED

Benefits

- Suitable for various vehicle models
- Easy installation for a precise light distribution
- Reduced glare for oncoming traffic

OSRAM LEDriving® ADAPTER product range (for H7-LED)

Product Reference		Product Number	V	W	K	COLOR			No.
64210DA01-1		4062172206532	-	-	-	-	2	20	14 ^{P.55}
64210DA02		4062172160414	-	-	-	-	2	20	15 ^{P.55}
64210DA03-1		4062172201872	-	-	-	-	2	20	16 ^{P.55}
64210DA04		4062172175029	-	-	-	-	2	20	17 ^{P.55}
64210DA05		4062172233170	-	-	-	-	2	20	18 ^{P.55}
64210DA07		4062172233835	-	-	-	-	2	20	20 ^{P.55}
64210DA08		4062172242745	-	-	-	-	2	20	21 ^{P.55}

Replacement lamps for off-road use OSRAM LEDriving® HL¹⁾

LED high and low beam lamps in a new dimension



NEW: OSRAM LEDriving® HL EASY

Features

- Ultra compact LED replacement for conventional H7/H18, H4/H19 and H15 high and low beam lamps as socket solution
- Optimized high-speed fan ensures active cooling
- Cool White
- Premium OSRAM quality

Benefits

- Easy plug&play installation with optimized compatibility – no adapter and caps needed
- Higher performance and high level light output thanks to maximized heat dissipation
- Better visibility thanks to daylight effect
- Reduced glaring thanks to an optimized light distribution

OSRAM LEDriving® HL EASY¹⁾ product range

Product Reference		Product Number	V	W	K	COLOR			No.
64193DWESY-HCB	P43t/PU43t-3 (H4/H19)	4062172312578	12	18.7/19	6,500	Cool White	2	10	-
64210DWESY-HCB	PX26d/PY26d-1 (H7/H18) ²⁾	4062172312554	12	16	6,500	Cool White	2	10	-
64176DWESY-HCB	PGJ23t-1 (H15)	4062172312592	12	3.8/16.5	6,500	Cool White	2	10	-



NEW: OSRAM LEDDriving® HL BRIGHT

Features

- Up to 300% more brightness³⁾
- Multi-compatible smart reference ring ensures a very compact LED replacement for a wide range of conventional high and low beam lamps
- Cool White color temperature of 6,000 K

Benefits

- More light allows to see farther and therefore react sooner
- Reduced glaring thanks to an optimized light distribution
- Better visibility thanks to daylight effect
- 4-year guarantee⁵⁾

OSRAM LEDDriving® HL BRIGHT¹⁾ product range

Product Reference		Product Number	V	W	K				
64150DWBRT-2HFB	P14.5s (H1)	4062172315579	12	13	6,000	Cool White	2	8	-
64193DWBRT-2HFB	P43t/PU43t-3 (H4/H19)	4062172315913	12	15/15	6,000	Cool White	2	8	-
64210DWBRT-2HFB ²⁾	PX26d/PY26d-1 (H7/H18)	4062172315937	12	19	6,000	Cool White	2	8	-
64211DWBRT-2HFB	PGJ19-X (H8/H11/H16/H9)	4062172315951	12	19	6,000	Cool White	2	8	-
9005DWBRT-2HFB	P20d /PY20d/PX20d (HB3/H10/HIR1)	4062172315975	12	19	6,000	Cool White	2	8	-
9006DWBRT-2HFB	P22d/PX22d (HB4/HIR2)	4062172315999	12	19	6,000	Cool White	2	8	-
9008DWBRT-2HFB	P26.4t (H13)	4062172316019	12	15/10	6,000	Cool White	2	8	-



NEW: OSRAM LEDDriving® HL INTENSE

Features

- Up to 350% more brightness⁴⁾
- Very compact LED replacement for conventional H7/H18 and H4/19 high and low beam lamps
- Top OSRAM technology provides optimized beam pattern
- Premium OSRAM quality made in Italy
- Top thermal management technology with integrated active cooling

Benefits

- Better visibility thanks to daylight effect
- Easy installation with wide OSRAM range of suitable accessories
- Reduced glaring thanks to an optimized light distribution
- 5-year guarantee⁵⁾ and counterfeit protection thanks to OSRAM Trust program
- High speed fan ensures maximized heat dissipation for more powerful performances

OSRAM LEDDriving® HL INTENSE¹⁾ product range

Product Reference		Product Number	V	W	K				
64193DWINT-2HFB ²⁾	P43t/PU43t-3 (H4/H19)	4062172306454	12	27/23	6,000	Cool White	2	8	-
64210DWINT-2HFB	PX26d/PY26d-1 (H7/H18)	4062172306430	12	21	6,000	Cool White	2	8	-

1) These products do not have ECE approval and must not be used on public roads in any exterior application. Public roads use leads to cancellation of operating license and loss of insurance coverage. Several countries forbid sale and use of these products. Please contact your local distributor for further information. | 2) See page 16 for accessories | 3) Compared to minimum ECE R112, for H7/H18 & H4/H19 | 4) Compared to minimum ECE R112 | 5) Refer to www.osram.com/am-guarantee for precise conditions



OSRAM LEDriving® FL¹⁾ LED fog lamps for maximum visibility



Features

- Cool White color temperature of 6,000 K
- Ultra compact LED replacement for conventional H8/H11/H16 and H10 fog lamps as socket solution
- Premium OSRAM quality

Benefits

- Better visibility in foggy situations with a perfect color match for xenon and LED headlights.
- Reduced glaring thanks to an optimized light distribution
- 3-year guarantee²⁾

OSRAM LEDriving® FL¹⁾ product range

Product Reference		Product Number	V	W	K				
67219CW	PGJ19 (H8/H11/H16) ³⁾	4052899 605046	12	9	6,000	Cool White	2	4	3 ^{P.50}
9745CW	PY20d (H10)	4052899 605060	12	9	6,000	Cool White	2	4	4 ^{P.50}
2604CW	PG20-7 (PSX24W)	4062172 058360	12	6.7	6,000	Cool White	2	4	5 ^{P.50}



Conventional lamp –
Halogen fog light

OSRAM LEDriving® FL –
LED fog light

OSRAM LEDriving® SL¹⁾ Wide range of interior and exterior signal lamps



Features³⁾

- High color temperatures of up to 6,000 K
- Replaces conventional signal lamps for interior and exterior application
- Long lifetime of up to 2,500 h with low energy consumption

Benefits³⁾

- Multiple light colors for a variety of customization options
- Simple installation
- 4-year guarantee²⁾

OSRAM LEDriving® SL¹⁾ product range

Product Reference		Product Number	V	W		K					
828DWP	PG18.5d-1 (P13W)	4062172 150279	12	1.6	48.3	6,000	-	Cool white	1	10	9 ^{P.50}
5201DWP	PG20-1 (PS19W)	4062172 150293	12	1.6	42.5	6,000	-	Cool white	1	10	10 ^{P.50}
2825DWP-02B	W2.1x9.5d (W5W)	4052899 620810	12	0.8	25.0	6,000	617-621	Cool white	2	20	15 ^{P.50}
2825DRP-02B	W2.1x9.5d (W5W)	4062172 150316	12	0.6	25.0	-	617-621	Red	2	10	15 ^{P.50}
2827DYP-02B	W2.1x9.5d (W5W/WY5W)	4062172 150330	12	0.5	25.0	-	592	Amber	2	10	15 ^{P.50}



OSRAM LEDriving® SL¹⁾ product range

Product Reference		Product Number	V	W		K					
921DWP-02B	W2.1x9.5d (W16W)	4062172150804	12	2.1	35.9	6,000	-	Cool white	2	10	16 ^{P.50}
921DRP-02B	W2.1x9.5d (W16W)	4062172160155	12	1.4	35.9	-	617-621	Red	2	10	16 ^{P.50}
6438DWP-01B	SV8.5-8 (C5W)	4062172150637	12	1.0	31.0	6,000	-	Cool white	1	5	6 ^{P.50}
6418DWP-01B	SV8.5-8 (C5W)	4062172150651	12	0.6	36.0	6,000	-	Cool white	1	5	7 ^{P.50}
6413DWP-01B	SV8.5-8 (C5W)	4062172150675	12	0.6	41.0	6,000	-	Cool white	1	5	8 ^{P.50}
7506DWP-02B	BA15s (P21W)	4062172152181	12	1.9	42.6	6,000	-	Cool white	2	10	11 ^{P.50}
7506DRP-02B	BA15s (P21W)	4062172152204	12	1.3	42.6	-	617-621	Red	2	10	11 ^{P.50}
7506DYP-02B	BA15s (P21W)	4062172152228	12	1.3	42.6	-	592	Amber	2	10	11 ^{P.50}
7507DYP-02B	BAU15s (PY21W)	4062172152242	12	1.3	42.6	-	592	Amber	2	10	13 ^{P.50}
7515DWP-02B	W3x16q (W21/5W)	4062172152266	12	1.9	36.3	6,000	-	Cool white	2	10	18 ^{P.50}
7515DRP-02B	W3x16d (W21/5W)	4062172152280	12	1.7	36.3	-	617-621	Red	2	10	18 ^{P.50}
7515DYP-02B	W3x16q (W21/5W)	4062172152303	12	1.3	36.3	-	592	Amber	2	10	18 ^{P.50}
7505DWP-02B	W3x16d (W21W)	4062172149235	12	2.0	36.3	6,000	-	Cool white	2	10	17 ^{P.50}
7505DRP-02B	W3x16d (W21W)	4062172149259	12	1.4	36.3	-	617-621	Red	2	10	17 ^{P.50}
7505DYP-02B	W3x16d (W21W)	4062172149273	12	1.3	36.3	-	592	Amber	2	10	17 ^{P.50}
7504DYP-02B	WX3x16d (WY21W)	4062172156004	12	1.3	36.3	-	592	Amber	2	10	19 ^{P.50}
7528DWP-02B	BAY15d (P21/5W)	4062172151726	12	2.0	42.6	6,000	-	Cool white	2	10	12 ^{P.50}
7528DRP-02B	BAY15d (P21/5W)	4062172151740	12	1.4	42.6	-	617-621	Red	2	10	12 ^{P.50}
7528DYP-02B	BAY15d (P21/5W)	4062172151702	12	1.3	42.6	-	592	Amber	2	10	12 ^{P.50}
3157DWP-02B	W3x16q (P27/7W)	4062172151641	12	2.0	42.6	6,000	-	Cool white	2	10	14 ^{P.50}
3157DRP-02B	W3x16q (P27/7W)	4062172151689	12	1.4	42.6	-	617-621	Red	2	10	14 ^{P.50}
3157DYP-02B	W3x16q (P27/7W)	4062172151665	12	1.3	42.6	-	592	Amber	2	10	14 ^{P.50}
3893DWP-02B	BA9s (T4W)	4062172150354	12	0.8	27.8	6,000	-	Cool white	2	10	14 ^{P.50}
5007DWP-02B	BA15s (R5W)	4062172222808	12	0.5	37.5	6,000	-	Cool white	2	10	-
5008DWP-02B	BA15s (R10W)	4062172222846	12	1.2	37.5	6,000	-	Cool white	2	10	-
2723DWP-02B	W2x4.6d (T5/W2.3W)	4062172254687	12	0.25	16.5	6,000	-	Cool white	2	10	-

OSRAM LEDriving® HLM¹⁾

Easy upgrade from conventional motorcycle headlights to cool white LED light



Features

- Cool White color temperature of 6,000 K
- LED replacement for conventional HS1 and T19 high and low beam lamps
- Compact plug and play design

Benefits

- Better visibility thanks to daylight effect
- Reduced glaring thanks to an optimized light distribution
- Easy installation

OSRAM LEDriving® HLM¹⁾ motorcycle product range

Product Reference		Product Number	V	W	K				
64185DWP-01B	PX43t (HS1)	4062172229494	12	5/5	6,000	Cool White	1	5	21 ^{P.50}
7335DWP-01B	P15d-25-1 (T19) ⁴⁾	4062172229531	12	5/5	6,000	Cool White	1	5	22 ^{P.50}

1) These products do not have ECE approval and must not be used on public roads in any exterior application. Public roads use leads to cancellation of operating license and loss of insurance coverage. Several countries forbid sale and use of these products. Please contact your local distributor for further information. | 2) Refer to www.osram.com/am-guarantee for precise conditions | 3) LEDriving® CANBUS CONTROL UNIT (P.16) avoid error messages on the board computer when using LED retrofits within 5W, 21W and 50 W applications | 4) no ECE equivalent type



OSRAM LEDriving® HLT¹⁾

Bright light for trucks (24V)



Features

- Cool White color temperature of 6,000 K
- LED replacement for conventional H1, H4 or H7 high and low beam lamps
- With external driver, for more performance and robustness

Benefits

- Better visibility thanks to daylight effect
- Reduced glaring thanks to an optimized light distribution
- 3-year OSRAM guarantee²⁾

OSRAM LEDriving® HLT¹⁾ (24V) truck product range

Product Reference		Product Number	V	W	K	COLOR			No.
64155DWS-2HFB P14.5s (H1)		4062172 183123	24	12	6,000	Cool White	2	8	23 ^{P.50}
64196DWS-2HFB P43t (H4)		4062172 183147	24	13/13	6,000	Cool White	2	8	24 ^{P.50}
64215DWS-2HFB PX26d (H7)		4062172 183161	24	18	6,000	Cool White	2	8	25 ^{P.50}

OSRAM LEDriving® ACCESSORIES

Making LED upgrades fit right in



Features

- Bypasses the vehicle's outage detection system to prevent error messages in board computers prompted by LED lamps with lower wattages
- Available with power up to 21W
- Robust component

Benefits

- Easily clips onto wires
- Enjoy full benefits of your OSRAM LED retrofits and fog lights
- Original OSRAM accessory
- 3-year guarantee²⁾

OSRAM LEDriving® CANBUS product range

Product Reference	Product Number	V	W			No.
LEDSC01-2HFB ³⁾	4062172 191142	12	12	2	4	-
LEDCBCTRL102	4052899 301993	12	21	2	10	-
LEDCBC101	4052899 090873	12	5	2	10	-



OSRAM ADAPTER⁴⁾ product range

Product Reference	Product Number	V	W			 No.
64210DA01	4062172160384	-	-	2	20	-
64210DA01-1	4062172206532	-	-	2	20	14 ^{P.55}
64210DA02	4062172160414	-	-	2	20	15 ^{P.55}
64210DA03	4062172183840	-	-	2	20	-
64210DA03-1	4062172201872	-	-	2	20	16 ^{P.55}
64210DA04	4062172175029	-	-	2	20	17 ^{P.55}
64210DA05	4062172233170	-	-	2	20	18 ^{P.55}
64210DA06	4062172183932	-	-	2	20	19 ^{P.55}
64210DA06-1	4062172201902	-	-	2	20	-
64210DA07	4062172233835	-	-	2	20	20 ^{P.55}
64210DA08	4062172242745	-	-	2	20	21 ^{P.55}

OSRAM CAP⁴⁾⁵⁾ product range

Product Reference	Product Number	V	W			 No.
LEDCAP01	4062172241878	-	-	2	8	10 ^{P.54}
LEDCAP02	4062172241908	-	-	2	8	11 ^{P.54}
LEDCAP03	4062172271394	-	-	2	8	12 ^{P.54}
LEDCAP04	4062172278560	-	-	2	8	13 ^{P.54}
LEDCAP06	4062172305952	-	-	2	8	-
LEDCAP07	4062172305983	-	-	2	8	-
▶ LEDCAP08	4062172309509	-	-	2	8	-
▶ LEDCAP09	4062172309530	-	-	2	8	-
▶ LEDCAP10	4062172325912	-	-	2	8	-
▶ LEDCAP11	4062172325981	-	-	2	8	-
▶ LEDCAP12	4062172326070	-	-	2	8	-

Coming soon

 **Replace your conventional lamps with LED retrofit lamps.**
Visit www.osram.com/retrofit-exchange

1) These products do not have ECE approval and must not be used on public roads in any exterior application. Public roads use leads to cancellation of operating license and loss of insurance coverage. Several countries forbid sale and use of these products. Please contact your local distributor for further information. | 2) Refer to www.osram.com/am-guarantee for precise conditions | 3) LEDriving® SMART CANBUS avoids error messages on the board computer when using LED lamps | 4) Only suitable for \pm H7 lamps | 5) Off-road use only



Xenon headlight lamps

Fascinatingly bright

OSRAM xenon lamps generate up to 220% more brightness compared to the minimum legal standard – at impressive color temperatures, as well as significantly lower energy consumption and longer life than halogen lamps. They are suitable for cars, trucks, buses and commercial vehicles.



OSRAM XENARC® NIGHT BREAKER® LASER (NEXT GEN)

Brightest OSRAM xenon light



Features

- Up to 220% more brightness¹⁾²⁾
- Up to 250 m long beam
- Up to 20% whiter light¹⁾
- 3-year guarantee⁷⁾

Benefits

- More light allows to see further and therefore react sooner
- Better visibility
- Modern look
- OSRAM quality for more customer satisfaction

OSRAM XENARC® NIGHT BREAKER® LASER (NEXT GEN) product range

Product Reference	ECE	Product Number	V	W		lm	K			
66140XNN ³⁾⁴⁾	D1S ⁵⁾	4052899631328	85	35	PK32d-2	3,200 ⁶⁾	4,500	1	4	1 ^{P.56}
66140XNN-HCB ³⁾⁴⁾	D1S ⁵⁾	4052899631281	85	35	PK32d-2	3,200 ⁶⁾	4,500	2	4	1 ^{P.56}
66240XNN ³⁾⁴⁾	D2S ⁵⁾	4052899631335	85	35	P32d-2	3,200 ⁶⁾	4,500	1	4	3 ^{P.56}
66240XNN-HCB ³⁾⁴⁾	D2S ⁵⁾	4052899631298	85	35	P32d-2	3,200 ⁶⁾	4,500	2	4	3 ^{P.56}
66340XNN ³⁾⁴⁾	D3S ⁵⁾	4052899631342	42	35	PK32d-5	3,200 ⁶⁾	4,400	1	4	1 ^{P.56}
66340XNN-HCB ³⁾⁴⁾	D3S ⁵⁾	4052899631304	42	35	PK32d-5	3,200 ⁶⁾	4,400	2	4	1 ^{P.56}
66440XNN ³⁾⁴⁾	D4S ⁵⁾	4052899631359	42	35	P32d-5	3,200 ⁶⁾	4,400	1	4	3 ^{P.56}
66440XNN-HCB ³⁾⁴⁾	D4S ⁵⁾	4052899631311	42	35	P32d-5	3,200 ⁶⁾	4,400	2	4	3 ^{P.56}

1) Compared to minimum ECE R98/R99 requirements | 2) D3S, D4S | 3) To be operated only with approved electronic control gear

4) XENARC® lamps should be replaced by a qualified mechanic | 5) Reduced UV emission | For projection headlights | ECE approval and DOT label | 6) ± 450 lm | 7) Refer to www.osram.com/am-guarantee for precise conditions



OSRAM XENARC® COOL BLUE® INTENSE (NEXT GEN)

Extra white light for LED look



Features

- Extra white light for LED look
- Color temperatures of up to 6,200 K⁽¹⁾²⁾
- Up to 150% more brightness⁽¹⁾³⁾

Benefits

- Modern look on the road
- High contrast
- More light allows to see farther and therefore react sooner

OSRAM XENARC® COOL BLUE® INTENSE product range

Product Reference	ECE	Product Number	V	W		lm	K				No.
66140CBN ⁽⁴⁾⁵⁾	D1S ⁽⁶⁾	4062172157322	85	35	PK32d-2	3,200 ⁽⁸⁾	6,200	1	4		1 ^{P.56}
66140CBN-HCB ⁽⁴⁾⁵⁾	D1S ⁽⁶⁾	4062172145275	85	35	PK32d-2	3,200 ⁽⁸⁾	6,200	2	4		1 ^{P.56}
66240CBN ⁽⁴⁾⁵⁾	D2S ⁽⁶⁾	4062172157353	85	35	P32d-2	3,200 ⁽⁸⁾	6,200	1	4		3 ^{P.56}
66240CBN-HCB ⁽⁴⁾⁵⁾	D2S ⁽⁶⁾	4062172111362	85	35	P32d-2	3,200 ⁽⁸⁾	6,200	2	4		3 ^{P.56}
66250CBN ⁽⁴⁾⁵⁾	D2R ⁽⁷⁾	4062172216913	85	35	P32d-3	2,800 ⁽⁸⁾	6,000	1	4		4 ^{P.56}
66340CBN ⁽⁴⁾⁵⁾	D3S ⁽⁶⁾	4062172157384	42	35	PK32d-5	3,200 ⁽⁸⁾	6,200	1	4		1 ^{P.56}
66340CBN-HCB ⁽⁴⁾⁵⁾	D3S ⁽⁶⁾	4062172145305	42	35	PK32d-5	3,200 ⁽⁸⁾	6,200	2	4		1 ^{P.56}
66440CBN ⁽⁴⁾⁵⁾	D4S ⁽⁶⁾	4062172157414	42	35	P32d-5	3,200 ⁽⁸⁾	6,200	1	4		3 ^{P.56}
66440CBN-HCB ⁽⁴⁾⁵⁾	D4S ⁽⁶⁾	4062172145350	42	35	P32d-5	3,200 ⁽⁸⁾	6,200	2	4		3 ^{P.56}
66548CBN ⁽⁴⁾⁵⁾	D8S ⁽⁶⁾	4062172148412	42	25	PK32d-1	2,000 ⁽⁸⁾	6,200	1	4		1 ^{P.56}

OSRAM XENARC® ULTRA LIFE

Superior life and 10-year guarantee



Features

- 10-year guarantee⁽⁹⁾
- Up to 4 times longer lifetime⁽¹⁰⁾
- Up to 300,000 km service life⁽¹¹⁾

Benefits

- Additional comfort due to reliable quality
- Saves time due to fewer workshop visits
- Longer replacement cycles

OSRAM XENARC® ULTRA LIFE product range

Product Reference	ECE	Product Number	V	W		lm	K				No.
66140ULT ⁽⁴⁾⁵⁾	D1S ⁽⁶⁾	4052899425514	85	35	PK32d-2	3,200 ⁽⁸⁾	4,300	1	4		1 ^{P.56}
66140ULT-HCB ⁽⁴⁾⁵⁾	D1S ⁽⁶⁾	4052899429598	85	35	PK32d-2	3,200 ⁽⁸⁾	4,300	2	4		1 ^{P.56}
66240ULT ⁽⁴⁾⁵⁾	D2S ⁽⁶⁾	4052899425576	85	35	P32d-2	3,200 ⁽⁸⁾	4,300	1	4		3 ^{P.56}
66240ULT-HCB ⁽⁴⁾⁵⁾	D2S ⁽⁶⁾	4052899429659	85	35	P32d-2	3,200 ⁽⁸⁾	4,300	2	4		3 ^{P.56}
66340ULT ⁽⁴⁾⁵⁾	D3S ⁽⁶⁾	4052899425606	42	35	PK32d-5	3,200 ⁽⁸⁾	4,300	1	4		1 ^{P.56}
66340ULT-HCB ⁽⁴⁾⁵⁾	D3S ⁽⁶⁾	4052899429710	42	35	PK32d-5	3,200 ⁽⁸⁾	4,300	2	4		1 ^{P.56}
66440ULT ⁽⁴⁾⁵⁾	D4S ⁽⁶⁾	4052899425637	42	35	P32d-5	3,200 ⁽⁸⁾	4,300	1	4		3 ^{P.56}
66440ULT-HCB ⁽⁴⁾⁵⁾	D4S ⁽⁶⁾	4052899429772	42	35	P32d-5	3,200 ⁽⁸⁾	4,300	2	4		3 ^{P.56}

1) D1S, D2S, D3S, D4S, D8S | 2) Measured in headlamps | 3) Compared to minimum ECE R98 requirements | 4) To be operated only with approved electronic control gear | 5) XENARC® lamps should be replaced by a qualified mechanic | 6) Reduced UV emission / For projection headlights / ECE approval and DOT label | 7) Reduced UV emission | With anti-glare strip for reflection headlights | ECE approval and DOT label | 8) ± 450 lm | 9) Refer to www.osram.com/am-guarantee for precise conditions | 10) Compared to standard xenon lamps | 11) With an average annual mileage of 14,259 km and 60% light on



OSRAM XENARC® ORIGINAL

4-year guarantee



Features

- 4-year guarantee¹⁾
- OEM Quality
- Original spare parts that exceed all ECE minimum standards

Benefits

- Additional comfort due to reliable quality
- Premium quality made in Germany
- Suitable for many xenon headlights

OSRAM XENARC® ORIGINAL product range

Product Reference	ECE	Product Number	V	W		lm	K				No.
66140 ²⁾³⁾	D1S ⁴⁾	4008321184276	85	35	PK32d-2	3,200 ⁶⁾	4,300	1	4		1 ^{P.56}
66140-1SCB ²⁾³⁾	D1S ⁴⁾	4052899600423	85	35	PK32d-2	3,200 ⁶⁾	4,300	1	4		1 ^{P.56}
66150 ²⁾³⁾	D1R ⁵⁾	4052899339828	85	35	PK32d-3	2,800 ⁶⁾	4,300	1	4		2 ^{P.56}
66240 ²⁾³⁾	D2S ⁴⁾	4008321184573	85	35	P32d-2	3,200 ⁶⁾	4,300	1	4		3 ^{P.56}
66240-1SCB ²⁾³⁾	D2S ⁴⁾	4052899600447	85	35	P32d-2	3,200 ⁶⁾	4,300	1	4		3 ^{P.56}
66250 ²⁾³⁾	D2R ⁵⁾	4008321184634	85	35	P32d-3	2,800 ⁶⁾	4,300	1	4		4 ^{P.56}
66340 ²⁾³⁾	D3S ⁴⁾	4052899199569	42	35	PK32d-5	3,200 ⁶⁾	4,300	1	4		1 ^{P.56}
66340-1SCB ²⁾³⁾	D3S ⁴⁾	4052899600485	42	35	PK32d-5	3,200 ⁶⁾	4,300	1	4		1 ^{P.56}
66350 ²⁾³⁾	D3R ⁵⁾	4008321129857	42	35	PK32d-6	2,800 ⁶⁾	4,300	1	4		2 ^{P.56}
66440 ²⁾³⁾	D4S ⁴⁾	4008321349392	42	35	P32d-5	3,200 ⁶⁾	4,300	1	4		3 ^{P.56}
66440-1SCB ²⁾³⁾	D4S ⁴⁾	4052899600508	42	35	P32d-5	3,200 ⁶⁾	4,300	1	4		3 ^{P.56}
66450 ²⁾³⁾	D4R ⁵⁾	4008321349576	42	35	P32d-6	2,800 ⁶⁾	4,300	1	4		4 ^{P.56}
66540 ³⁾	D5S ⁴⁾	4052899600522	12	25	PK32d-7	2,000 ⁷⁾	4,800	1	4		75 ^{P.57}
66548 ²⁾³⁾	D8S ⁴⁾	4008321787019	42	25	PK32d-1	2,000 ⁸⁾	4,500	1	4		1 ^{P.56}

A perfectly matched OSRAM system solution with ballast, terminal and connecting cables is available for all XENARC® D1S/R, D3S/R and D8S lamps. Please consult your OSRAM contact if required.

1) Refer to www.osram.com/am-guarantee for precise conditions

2) To be operated only with approved electronic control gear

3) XENARC® lamps should be replaced by a qualified mechanic

4) Reduced UV emission | For projection headlights | ECE approval and DOT label

5) Reduced UV emission | With anti-glare strip for projection headlights | ECE approval and DOT label

6) ± 450 lm

7) + 300 lm/-200 lm

8) ± 300 lm



Halogen lamps for cars

The most trusted traditional light

OSRAM halogen solutions are our best-selling proven choice among headlight lamps. From original, performance, design, and comfort products, each customer can choose the exact lamp which best fits their personal needs – whether it is an original spare part or a value-added product.



OSRAM NIGHT BREAKER® 200 Brightest OSRAM halogen light



Features

- Up to 200% more brightness¹⁾
- Up to 150 m long beam
- Mirror chrome cap
- Up to 20% whiter light¹⁾

Benefits

- More light allows to see farther and therefore react sooner
- Better visibility
- Modern look
- Signs, obstacles and hazards can be recognized sooner

OSRAM NIGHT BREAKER® 200 product range

Product Reference	ECE	Product Number	V	W				
64193NB200	H4	4062172212281	12	60/55	P43t	1	100	7 ^{P.56}
64193NB200-HCB	H4	4062172198158	12	60/55	P43t5s	2	10	7 ^{P.56}
64210NB200	H7	4062172212250	12	55	PX26d	1	100	8 ^{P.56}
64210NB200-HCB	H7	4062172198134	12	55	PX26d	2	10	8 ^{P.56}
64211NB200	H11	4062172308236	12	55	PGJ19-2	1	100	14 ^{P.56}
64211NB200-HCB	H11	4062172308212	12	55	PGJ19-2	2	10	14 ^{P.56}

1) Compared to minimum ECE R112/R37 requirements



OSRAM NIGHT BREAKER® LASER

Our 2nd most powerful halogen lamp



Features

- Up to 150% more brightness¹⁾
- Up to 150 m long beam
- Up to 20% whiter light¹⁾
- More light performance due to innovative laser ablation technology²⁾

Benefits

- More light allows to see farther and therefore react sooner
- Better visibility
- Modern look
- Signs, obstacles and hazards can be recognized sooner

OSRAM NIGHT BREAKER® LASER product range

Product Reference	ECE	Product Number	V	W				
64150NL	H1	4052899991309	12	55	P14.5s	1	100	5 ^{P.56}
64150NL-01B	H1	4062172114936	12	55	P14.5s	1	10	5 ^{P.56}
64150NL-HCB	H1	4062172114899	12	55	P14.5s	2	10	5 ^{P.56}
64151NL	H3	4052899991330	12	55	PK22s	1	100	6 ^{P.56}
64151NL-HCB	H3	4062172114912	12	55	PK22s	1	10	6 ^{P.56}
64193NL	H4	4052899991361	12	60/55	P43t	1	100	7 ^{P.56}
64193NL-01B	H4	4062172114431	12	60/55	P43t	1	10	7 ^{P.56}
64193NL-HCB	H4	4062172114318	12	60/55	P43t	2	10	7 ^{P.56}
64210NL	H7	4052899991392	12	55	PX26d	1	100	8 ^{P.56}
64210NL-01B	H7	4062172114455	12	55	PX26d	1	10	8 ^{P.56}
64210NL-HCB	H7	4062172114332	12	55	PX26d	2	10	8 ^{P.56}
64212NL	H8	4052899998827	12	35	PGJ19-1	1	100	9 ^{P.56}
64212NL-HCB	H8	4062172114370	12	35	PGJ19-1	2	10	9 ^{P.56}
64211NL	H11	4052899991422	12	55	PGJ19-2	1	100	14 ^{P.56}
64211NL-01B	H11	4062172114479	12	55	PGJ19-2	1	10	14 ^{P.56}
64211NL-HCB	H11	4062172114356	12	55	PGJ19-2	2	10	14 ^{P.56}
9005NL	HB3	4052899998858	12	60	P20d	1	100	22 ^{P.56}
9005NL-HCB	HB3	4062172114394	12	60	P20d	2	10	22 ^{P.56}
9006NL	HB4	4052899998889	12	51	P22d	1	100	24 ^{P.56}
9006NL-HCB	HB4	4062172114417	12	51	P22d	2	10	24 ^{P.56}

OSRAM NIGHT BREAKER® SILVER

Excellent performance-lifetime ratio



Features

- Up to 100% more brightness¹⁾
- Up to 130 m long beam
- Excellent performance-lifetime ratio

Benefits

- More light allows to see farther and therefore react sooner
- Better visibility
- More light at a reasonable lifetime

OSRAM NIGHT BREAKER® SILVER product range

Product Reference	ECE	Product Number	V	W				
64150NBS	H1	4052899992573	12	55	P14.5s	1	100	5 ^{P.56}
64150NBS-01B	H1	4052899992399	12	55	P14.5s	1	10	5 ^{P.56}
64150NBS-HCB	H1	4052899992252	12	55	P14.5s	2	10	5 ^{P.56}



OSRAM NIGHT BREAKER® SILVER product range

Product Reference	ECE	Product Number	V	W				
64193NBS	H4	4052899992603	12	60/55	P43t	1	100	7 ^{P.56}
64193NBS-01B	H4	4052899992450	12	60/55	P43t	1	10	7 ^{P.56}
64193NBS-HCB	H4	4052899992337	12	60/55	P43t	2	10	7 ^{P.56}
64210NBS	H7	4052899992634	12	55	PX26d	1	100	8 ^{P.56}
64210NBS-01B	H7	4052899992511	12	55	PX26d	1	10	8 ^{P.56}
64210NBS-HCB	H7	4052899992719	12	55	PX26d	2	10	8 ^{P.56}
64211NBS	H11	4052899992665	12	55	PGJ19-2	1	100	14 ^{P.56}
64211NBS-HCB	H11	4052899992818	12	55	PGJ19-2	2	10	14 ^{P.56}

OSRAM COOL BLUE® INTENSE (NEXT GEN)

Extra white light for LED look



Features

- Extra white light for LED look
- Color temperatures of up to 5,000 K⁽³⁾⁴⁾
- Up to 100% more brightness⁽¹⁾³⁾
- Modern design with silver cap⁵⁾

Benefits

- Modern and stylish look
- More light allows to see farther and therefore react sooner
- Ideal for use in clear-glass headlights

OSRAM COOL BLUE® INTENSE product range

Product Reference	ECE	Product Number	V	W				
64150CBN	H1	4058075520356	12	55	P14.5s	1	100	5 ^{P.56}
64150CBN-01B	H1	4062172251662	12	55	P14.5s	1	10	5 ^{P.56}
64150CBN-HCB	H1	4062172173681	12	55	P14.5s	2	10	5 ^{P.56}
64193CBN	H4	4062172149334	12	60/55	P43t	1	100	7 ^{P.56}
64193CBN-01B	H4	4062172251686	12	60/55	P43t	1	10	7 ^{P.56}
64193CBN-HCB	H4	4062172149297	12	60/55	P43t	2	10	7 ^{P.56}
64210CBN	H7	4062172149358	12	55	PX26d	1	100	8 ^{P.56}
64210CBN-01B	H7	4062172251709	12	55	PX26d	1	10	8 ^{P.56}
64210CBN-HCB	H7	4062172149310	12	55	PX26d	2	10	8 ^{P.56}
64212CBN-HCB	H8	4062172214988	12	35	PGJ19-1	2	10	9 ^{P.56}
64211CBN-HCB	H11	4062172214940	12	55	PGJ19-2	2	10	14 ^{P.56}
64176CBN	H15	4062172215527	12	55/15	PGJ23t-1	1	100	17 ^{P.56}
64176CBN-HCB	H15	4062172215008	12	55/15	PGJ23t-1	2	10	17 ^{P.56}
9005CBN-HCB	HB3	4062172215022	12	60	P20d	2	10	22 ^{P.56}
9006CBN-HCB	HB4	4062172215046	12	51	P22d	2	10	24 ^{P.56}
9012CBN	HIR2	4062172215572	12	55	PX22d	1	100	28 ^{P.56}
2825CBN	W5W	4062172218757	12	5	W2.1x9.5d	10	50	51 ^{P.57}
2825CBN-02B	W5W	4062172215060	12	5	W2.1x9.5d	2	20	51 ^{P.57}

1) Compared to minimum ECE R112/R37 requirements

2) H4/H7/H8/H11/HB3/HB4

3) H1, H4, H7, H11, HB3, HB4, HIR2

4) Measured in headlamps

5) H4, H7, H8, H11, HB4



OSRAM DIADEM® CHROME

Only amber during operation



Features

- Chrome design
- Amber when ON
- Homogenous appearance

Benefits

- Cutting edge interference and absorber coating
- Only amber when operating, otherwise almost invisible
- Exclusive chrome look

OSRAM DIADEM® CHROME product range

Product Reference	ECE	Product Number	V	W				
2827DC-02B ¹⁾	WY5W	4008321972750	12	5	W2.1x9.5d	2	20	51 ^{P.57}
7507DC-02B ¹⁾	PY21W	4008321972774	12	21	BAU15s	2	20	37 ^{P.56}

OSRAM ULTRA LIFE

Longer life and 4-year guarantee



Features

- 4-year guarantee²⁾
- Up to 4 times longer lifetime³⁾
- Up to 100,000 km service life⁴⁾

Benefits

- Additional comfort due to reliable quality
- Saves time due to fewer workshop visits
- Longer replacement cycles

OSRAM ULTRA LIFE product range

Product Reference	ECE	Product Number	V	W				
64150ULT	H1	4008321416209	12	55	P14.5s	1	100	5 ^{P.56}
64150ULT-01B	H1	4008321416100	12	55	P14.5s	1	10	5 ^{P.56}
64150ULT-HCB	H1	4008321416162	12	55	P14.5s	2	10	5 ^{P.56}
64193ULT	H4	4008321416230	12	60/55	P43t	1	100	7 ^{P.56}
64193ULT-01B	H4	4008321416124	12	60/55	P43t	1	10	7 ^{P.56}
64193ULT-HCB	H4	4008321416186	12	60/55	P43t	2	10	7 ^{P.56}
64210ULT	H7	4008321416261	12	55	PX26d	1	100	8 ^{P.56}
64210ULT-01B	H7	4052899436534	12	55	PX26d	1	10	8 ^{P.56}
64210ULT-HCB	H7	4052899436558	12	55	PX26d	2	10	8 ^{P.56}
64211ULT	H11	4052899431164	12	55	PGJ19-2	1	100	14 ^{P.56}
64211ULT-01B	H11	4052899436473	12	55	PGJ19-2	1	10	14 ^{P.56}
64211ULT-HCB	H11	4052899436510	12	55	PGJ19-2	2	10	14 ^{P.56}
7506ULT	P21W	4008321415349	12	21	BA15s	10	50	37 ^{P.56}
7506ULT-02B	P21W	4008321415141	12	21	BA15s	2	20	37 ^{P.56}
7507ULT ⁵⁾	PY21W	4008321413147	12	21	BAU15s	10	50	37 ^{P.56}
7507ULT-02B ⁴⁾	PY21W	4008321415165	12	21	BAU15s	2	20	37 ^{P.56}
7528ULT	P21/5W	4008321413116	12	21/5	BAY15d	10	50	38 ^{P.56}
7528ULT-02B	P21/5W	4008321415288	12	21/5	BAY15d	2	20	38 ^{P.56}
2825ULT	W5W	4008321413024	12	5	W2.1x9.5d	10	50	51 ^{P.57}
2825ULT-02B	W5W	4008321415189	12	5	W2.1x9.5d	2	20	51 ^{P.57}



OSRAM ULTRA LIFE product range

Product Reference	ECE	Product Number	V	W				No.
5007ULT	R5W	4008321415370	12	5	BA15s	10	50	47 ^{P.57}
5007ULT-02B	R5W	4008321415202	12	5	BA15s	2	20	47 ^{P.57}
5008ULT	R10W	4008321415400	12	10	BA15s	10	50	47 ^{P.57}
5008ULT-02B	R10W	4008321415226	12	10	BA15s	2	20	47 ^{P.57}
6418ULT	C5W	4008321413086	12	5	SV8.5-8	10	50	35 ^{P.56}
6418ULT-02B	C5W	4008321415240	12	5	SV8.5-8	2	20	35 ^{P.56}
64132ULT	H6W	4008321413178	12	6	BAX9s	10	50	36 ^{P.56}
64132ULT-02B	H6W	4008321415325	12	6	BAX9s	2	20	36 ^{P.56}
64137ULT ⁴⁾	HY21W	4052899910256	12	21	BAW9s	10	50	34 ^{P.56}

OSRAM Original LINE 12V
Original spare part



Features

- OEM Quality
- Original spare parts that exceed all ECE minimum standards
- Wide product range

Benefits

- Tried and trusted in millions of vehicles of well-known manufacturers
- Premium quality made in Germany
- Suitable for the most common applications

OSRAM ORIGINAL LINE 12V headlight lamps / auxiliary lamps product range

Product Reference	ECE	Product Number	V	W				No.
64150	H1	4050300001487	12	55	P14.5s	1	100	5 ^{P.56}
64150-01B	H1	4050300925264	12	55	P14.5s	1	10	5 ^{P.56}
64151	H3	4050300001494	12	55	PK22s	1	100	6 ^{P.56}
64151-01B	H3	4050300925349	12	55	PK22s	1	10	6 ^{P.56}
64193	H4	4050300001470	12	60/55	P43t	1	100	7 ^{P.56}
64193-01B	H4	4050300925127	12	60/55	P43t	1	10	7 ^{P.56}
64210	H7	4050300332185	12	55	PX26d	1	100	8 ^{P.56}
64210-01B	H7	4050300925202	12	55	PX26d	1	10	8 ^{P.56}
64212	H8	4050300498751	12	35	PGJ19-1	1	100	9 ^{P.56}
64212-01B	H8	4052899262478	12	35	PGJ19-1	1	10	9 ^{P.56}
64242 ⁶⁾	H8B	4008321055422	12	35	PGJY19-1	1	100	10 ^{P.56}
64213	H9	4050300524368	12	65	PGJ19-5	1	100	11 ^{P.56}
64243 ⁶⁾	H9B	4008321055477	12	65	PGJY19-5	1	100	12 ^{P.56}
9145	H10	4052899348622	12	42	PY20d	1	100	13 ^{P.56}
64211	H11	4050300524313	12	55	PGJ19-2	1	100	14 ^{P.56}
64211-01B	H11	4008321171252	12	55	PGJ19-2	1	10	14 ^{P.56}
64241 ¹⁾	H11B	4008321054654	12	55	PGJY19-2	1	100	15 ^{P.56}
9008	H13	4008321939401	12	60/55	P26.4t	1	10	16 ^{P.56}

1) Amber light for clear indicator lights
 2) Refer to www.osram.com/am-guarantee for precise conditions
 3) Compared with standard lamps
 4) With an average annual mileage of 14,259 km and 60% light on
 5) Amber lamps for clear indicator lights
 6) Successor type for BILUX®-AS® lamp (product reference 7951)



OSRAM ORIGINAL LINE 12V headlight lamps / auxiliary lamps product range

Product Reference	ECE	Product Number	V	W					No.
64176	H15	4008321218391	12	55/15	PGJ23t-1	1	100		17 ^{P.56}
64219L+	H16	4008321626783	12	19	PGJ19-3	1	100		18 ^{P.56}
64180L	H18	4052899479968	12	55	PY26d-1	1	100		19 ^{P.56}
64181L	H19	4052899599017	12	60/55	PU43t-3	1	100		20 ^{P.56}
880	H27W/1	4008321542977	12	27	PG13	1	100		31 ^{P.56}
881	H27W/2	4008321543004	12	27	PGJ13	1	100		31 ^{P.56}
9005	HB3	4050300137193	12	60	P20d	1	100		22 ^{P.56}
9005-01B	HB3	4008321171214	12	60	P20d	1	10		22 ^{P.56}
9005XS	HB3A	4052899982567	12	60	P20d	1	100		23 ^{P.56}
9006	HB4	4050300012650	12	51	P22d	1	100		24 ^{P.56}
9006-01B	HB4	4008321171238	12	51	P22d	1	10		24 ^{P.56}
9006XS	HB4A	4008321554284	12	51	P22d	1	100		25 ^{P.56}
9007	HB5	4050300148816	12	65/55	PX29t	1	200		26 ^{P.56}
9011	HIR1	4008321863966	12	65	PX20d	1	100		27 ^{P.56}
9012	HIR2	4008321863997	12	55	PX22d	1	100		27 ^{P.56}
9012-01B	HIR2	4062172294720	12	55	PX22d	1	10		27 ^{P.56}
7506	P21W	4050300838120	12	21	BA15s	10	50		37 ^{P.56}
7506-02B	P21W	Page 72	12	21	BA15s	2	20		37 ^{P.56}
7507 ¹⁾	PY21W	4050300891477	12	21	BAU15s	10	50		37 ^{P.56}
7507-02B ¹⁾	PY21W	Page 72	12	21	BAU15s	2	20		37 ^{P.56}
7225	P21/4W	4050300891514	12	21/4	BAZ15d	10	50		38 ^{P.56}
7225-02B	P21/4W	Page 72	12	21/4	BAZ15d	2	20		38 ^{P.56}
7240	-	4050300838007	12	21/5	BA15d	10	50		38 ^{P.56}
7528	P21/5W	4050300838069	12	21/5	BAY15d	10	50		38 ^{P.56}
7528-02B	P21/5W	Page 72	12	21/5	BAY15d	2	20		38 ^{P.56}
3860	-	4008321095756	12	5	BA9s	10	50		48 ^{P.57}
3893	T4W	4050300838489	12	4	BA9s	10	50		48 ^{P.57}
3893-02B	T4W	Page 72	12	4	BA9s	2	20		48 ^{P.57}
2820	-	4008321094094	12	2	W2.1x9.5d	10	50		50 ^{P.57}
2821	W3W	4050300838663	12	3	W2.1x9.5d	10	50		50 ^{P.57}
2821-02B	W3W	Page 2	12	3	W2.1x9.5d	2	20		50 ^{P.57}
2825	W5W	4050300838632	12	5	W2.1x9.5d	10	50		51 ^{P.57}
2825-02B	W5W	Page 72	12	5	W2.1x9.5d	2	20		51 ^{P.57}
2827NA ¹⁾	WY5W	4052899570795	12	5	W2.1x9.5d	10	50		51 ^{P.57}
2827NA-02B ¹⁾	WY5W	Page 72	12	5	W2.1x9.5d	2	20		51 ^{P.57}
2886X	-	4008321094667	12	6	W2.1x9.5d	10	50		51 ^{P.57}
921	W16W	4008321100948	12	16	W2.1x9.5d	10	50		52 ^{P.57}
921-02B	W16W	Page 72	12	16	W2.1x9.5d	2	20		52 ^{P.57}
921NA ¹⁾	WY16W	4052899230460	12	16	W2.1x9.5d	10	50		53 ^{P.57}
7504 ¹⁾	WY21W	4008321165473	12	21	WX3x16d	10	50		54 ^{P.57}
7504-02B ¹⁾	WY21W	4062172294881	12	21	WX3x16d	2	20		54 ^{P.57}
7505	W21W	4052899324244	12	21	W3x16d	10	50		54 ^{P.57}
7505-02B	W21W	Page 72	12	21	W3x16d	2	20		54 ^{P.57}
7515	W21/5W	4052899324312	12	21/5	W3x16q	10	50		55 ^{P.57}
7515-02B	W21/5W	Page 72	12	21/5	W3x16q	2	20		55 ^{P.57}
2721	-	4050300838540	12	1.2	W2x4.6d	10	50		57 ^{P.57}
2721-02B	-	Page 73	12	1.2	W2x4.6d	2	20		57 ^{P.57}
2722	-	4008321094803	12	2	W2x4.6d	10	50		57 ^{P.57}
2722-02B	-	Page 73	12	2	W2x4.6d	2	20		57 ^{P.57}
2723	W2.3W	4008321094834	12	2.3	W2x4.6d	10	50		49 ^{P.57}
64132	H6W	4008321094896	12	6	BAX9s	10	50		36 ^{P.56}
64136	H21W	4008321095190	12	21	BAY9s	10	50		33 ^{P.56}
5007	R5W	4050300838427	12	5	BA15s	10	50		47 ^{P.57}
5007-02B	R5W	Page 73	12	5	BA15s	2	20		47 ^{P.57}
5008	R10W	4050300838212	12	10	BA15s	10	50		47 ^{P.57}
5008-02B	R10W	Page 73	12	10	BA15s	2	20		47 ^{P.57}
5009 ¹⁾	RY10W	4008321095442	12	10	BAU15s	10	50		47 ^{P.57}



OSRAM ORIGINAL LINE 12V headlight lamps / auxiliary lamps product range

Product Reference	ECE	Product Number	V	W				
6411	-	4050300891354	12	10	SV8.5-8	10	50	60 ^{P.57}
6411-02B	-	Page 73	12	10	SV8.5-8	2	20	60 ^{P.57}
64111 ²⁾	-	4008321095015	12	5	BA9s	10	50	64 ^{P.57}
64111-02B ²⁾	-	Page 73	12	5	BA9s	2	20	64 ^{P.57}
64113	-	4008321095046	12	10	BA9s	10	50	64 ^{P.57}
64115	-	4008321095077	12	20	BA9s	10	50	64 ^{P.57}
6413	-	4050300891439	12	5	SV8.5-8	10	50	60 ^{P.57}
6418	C5W	4050300838397	12	5	SV8.5-8	10	50	35 ^{P.56}
6418-02B	C5W	Page 73	12	5	SV8.5-8	2	20	35 ^{P.56}
6428	-	4008321094384	12	3	SV7-8	10	50	61 ^{P.57}
6438	-	4008321094353	12	10	SV8.5-8	10	50	62 ^{P.57}
6438-02B	-	Page 73	12	10	SV8.5-8	2	20	62 ^{P.57}
6461	-	4008321094261	12	10	SV8.5-8	10	50	63 ^{P.57}
6486X	-	4008321094292	12	6	SV8.5-8	10	50	-
2351MFX6	-	4008321096852	12	1.2	BX8.4d	10	50	65 ^{P.57}
2352MFX6	-	4008321097149	12	2	BX8.4d	10	50	66 ^{P.57}
2452MFX6	-	4008321097118	12	1.5	BX8.4d	10	50	67 ^{P.57}
2473MFX6	-	4008321096821	12	1.12	BX8.4d	10	50	68 ^{P.57}
2721MFX	-	4008321297150	12	1.2	BX8.5d	10	50	70 ^{P.57}
2722MFX	-	4008321297181	12	2	BX8.5d	10	50	72 ^{P.57}
2721MF	-	4050300891255	12	1.2	B8.5d	10	50	69 ^{P.57}
2722MF	-	4008321096791	12	2	B8.5d	10	50	71 ^{P.57}
828	P13W	4062172094283	12	13	PG18,5d-1	1	100	74 ^{P.57}
3156	P27W	4008321090621	12	27	W2.5x16d	10	50	39 ^{P.56}
3157	P27/7W	4052899183414	12	27/7	W2.5x16q	10	50	40 ^{P.56}
3157A	-	4052899304291	12	27/7	W2.5x16q	10	50	40 ^{P.56}
3757AK ¹⁾	PY27/7W	4052899178731	12	27/7	WX2.5x16q	10	50	41 ^{P.56}
3796	-	4050300891309	12	2	Ba9s	10	50	59 ^{P.57}
5201	PS19W	4052899600546	12	19	PG20-1	1	100	44 ^{P.57}
5202	PS24W	4052899600584	12	24	PG20-3	1	100	45 ^{P.57}
2504	PSX24W	4052899600560	12	24	PG20-7	1	100	46 ^{P.57}
6851	PSX26W	4062172160100	12	26	PG18.5d-3	1	100	74 ^{P.57}

1) Amber lamps for clear indicator lights

2) Also available with glass base (product reference 6411150 or 6411350)

The suffix on the product reference indicates the board thickness:

MFX6: 1.5mm

MF: 2.0mm

MFX: 1.5mm



OSRAM MINIBOX

Mobile lamp replacement



Features

- Range of most important spare lamps
- Clear labeling and application illustration
- Original spare parts that exceed all ECE minimum standards

Benefits

- You'll always have the right spare lamps at hand
- Easy identification
- Premium quality made in Germany
- Mandatory in many countries

OSRAM MINIBOX product range

H1 ORIGINAL box

The H1 box is equipped with one H1 headlight lamp and contains the following five most important spare lamps and three flat fuses.

H4 ORIGINAL box

The H4 box is equipped with one H4 headlight lamp and contains the following five most important spare lamps and three flat fuses.

H7 ORIGINAL box

The H7 box is equipped with one H7 headlight lamp and contains the following five most important spare lamps and three flat fuses.

H1/H7 ORIGINAL box

The H1/H7 box is equipped with one H1 and one H7 headlight lamp and contains the following five most important spare lamps and three flat fuses.

	Product Number	Product Reference	ECE	i
H1 box	4050300875217	CLK H1	H1	Headlight + five spare lamps and three flat fuses
H4 box	4050300873398	CLK H4	H4	Headlight + five spare lamps and three flat fuses
H7 box	4050300876375	CLK H7	H7	Headlight + five spare lamps and three flat fuses
H1/H7 box	4052899522640	CLK H1/H7	H1/H7	Headlights + five spare lamps and three flat fuses
All boxes	7506		P21W	Brake and tail light
	7507		PY21W	Indicator light, amber
	7528		P21/5W	Brake/tail light
	5007		R5W	Tail light and license plate light
	2825		W5W	Parking light
				15A, 20A, 30A flat fuses



Halogen lamps for buses and trucks

Extreme durability, extreme high- performance

At OSRAM, vehicle drivers and fleet managers can choose from a wide range of high-performance truck lamps that not only meet the highest OEM quality requirements, but even exceed European standards. Their extremely long service life enhances driving comfort and reduces maintenance time and fleet costs.



OSRAM TRUCKSTAR® PRO Brightest OSRAM truck light



Features

- Up to 2.5x more lifetime¹⁾
- Up to 120% more brightness²⁾³⁾
- Very high vibration resistance

Benefits

- Reduced downtime and fleet costs
- More light allows to see farther and therefore react sooner
- Suitable for heavy duty applications

OSRAM TRUCKSTAR® PRO product range

Product Reference	ECE	Product Number	V	W				No.
64155TSP	H1	4008321784179	24	70	P14.5s	1	100	5 ^{P.56}
64155TSP-HCB	H1	4008321784209	24	70	P14.5s	2	10	5 ^{P.56}
64156TSP	H3	4062172159401	24	70	PK22s	1	100	6 ^{P.56}
64196TSP	H4	4062172150491	24	75/70	P43t	1	100	7 ^{P.56}
64196TSP-HCB	H4	4062172150439	24	75/70	P43t	2	10	7 ^{P.56}
64215TSP	H7	4062172150521	24	70	PX26d	1	100	8 ^{P.56}
64215TSP-HCB	H7	4062172150453	24	70	PX26d	2	10	8 ^{P.56}
64216TSP	H11	4062172150552	24	70	PGJ19-2	1	100	14 ^{P.56}
64216TSP-HCB	H11	4062172150477	24	70	PGJ19-2	2	10	14 ^{P.56}
7510TSP ⁴⁾	PY21W	4062172158435	24	21	BAU15s	10	50	37 ^{P.56}
7511TSP	P21W	4062172158466	24	21	BA15s	10	50	37 ^{P.56}

1) Compared with standard lamps | 2) H1, H4, H7, H11 | 3) Compared to minimum ECE R112 requirements | 4) Amber lamps for clear indicator lights



OSRAM TRUCKSTAR® PRO product range

Product Reference	ECE	Product Number	V	W				No.
7537TSP	P21/5W	4062172158497	24	21/5	BAY15d	10	50	38 ^{P.56}
2845TSP	W5W	4062172158312	24	5	W2.1x9.5d	10	50	51 ^{P.57}
5627TSP	R5W	4062172158374	24	5	BA15s	10	50	47 ^{P.57}
5637TSP	R10W	4062172158404	24	10	BA15s	10	50	47 ^{P.57}
3930TSP	T4W	4062172158343	24	4	BA9s	10	50	48 ^{P.57}

OSRAM Original LINE 24V Original spare part for trucks



Features

- OEM Quality
- Original spare parts that exceed all ECE minimum standards
- Wide product range

Benefits

- Tried and trusted in millions of vehicles of well-known manufacturers
- Premium quality made in Europe
- Suitable for the most common applications

OSRAM ORIGINAL LINE 24V headlight lamps / auxiliary lamps product range

Product Reference	ECE	Product Number	V	W				No.
64155	H1	4050300016498	24	70	P14.5s	1	100	5 ^{P.56}
64156	H3	4050300016535	24	70	PK22s	1	100	6 ^{P.56}
64196	H4	4050300016542	24	75/70	P43t	1	100	7 ^{P.56}
94196	H4	4050300250632	24	75/70	P43t	1	100	7 ^{P.56}
64215	H7	4050300386522	24	70	PX26d	1	100	8 ^{P.56}
64177	H15	4008321536556	24	20/60	PGJ23t-1	1	100	17 ^{P.56}
7511	P21W	4050300838090	24	21	BA15s	10	50	37 ^{P.56}
7537	P21/5W	4050300838038	24	21/5	BAY15d	10	50	38 ^{P.56}
7529	-	4050300891774	24	15	BA15s	10	50	37 ^{P.56}
5626	R5W	4008321095336	24	5	BA15d	10	50	47 ^{P.57}
5627	R5W	4050300838335	24	5	BA15s	10	50	47 ^{P.57}
5637	R10W	4050300831459	24	10	BA15s	10	50	47 ^{P.57}
3797	-	4050300891668	24	2	BA9s	10	50	48 ^{P.57}
3930	T4W	4050300838366	24	4	BA9s	10	50	48 ^{P.57}
64138	H21W	4008321094988	24	21	BAY9s	10	50	33 ^{P.57}
2341	-	4008321132529	24	1	W2x4.6d	10	50	56 ^{P.57}
2840	-	4008321094698	24	2	W2.1x9.5d	10	50	58 ^{P.57}
2841	W3W	4008321094728	24	3	W2.1x9.5d	10	50	50 ^{P.57}
2845	W5W	4050300891552	24	5	W2.1x9.5d	10	50	51 ^{P.57}
2741	-	4050300838519	24	1.2	W2x4.6d	10	50	57 ^{P.57}
6421	-	4008321090768	24	3	SV8.5-8	10	50	60 ^{P.57}
6423	C5W	4050300831435	24	5	SV8.5-8	10	50	35 ^{P.56}
6424	-	4050300891712	24	5	SV8.5-8	10	50	60 ^{P.57}
6429	-	4008321090836	24	10	SV8.5-8	10	50	60 ^{P.57}
6430	-	4008321094414	24	3	SV8.5-8	10	50	61 ^{P.57}
2741MF ¹⁾	-	4050300891606	24	1.2	B8.5d	10	50	73 ^{P.57}
2741MFX ¹⁾	-	4008321297211	24	1.2	BX8.5d	10	50	73 ^{P.57}

1) The suffix on the product reference indicates the board thickness: MF: 2.0mm | MFX: 1.5 mm



OSRAM spare lamp kit 24V

Reserve light for trucks and buses



Features

- Range of most important spare lamps
- Clear labeling and application illustration
- Original spare parts that exceed all ECE minimum standards

Benefits

- You'll always have the right spare lamps at hand
- Easy identification
- Premium quality made in Germany

OSRAM spare lamp box 24V product range

H7 TRUCKSTAR® PRO box – equipped with two H7 TRUCKSTAR® PRO headlight lamps and contains the following double sets of the six most important spare lamps and three flat fuses.

Product Number: 4062172225588	Product Reference	ECE	i
	64215TSP	H7	Headlight
	7511TSP	P21W	Brake and tail light
	7510TSP	PY21W	Indicator light, amber
	7537TSP	P21/5W	Brake/tail light
	5627TSP	R5W	Tail light and license plate light
	5637TSP	R10W	Parking light
	3930TSP	T4W	Park and position light
			15 A, 20 A, 30 A flat fuses

H4 ORIGINAL box – equipped with two H4 headlight lamps and contains the following double sets of the six most important spare lamps and three flat fuses.

Product Number: 4008321583192	Product Reference	ECE	i
	64196	H4	Headlight
	7511	P21W	Brake and tail light
	7510TSP	PY21W	Indicator light, amber
	7537	P21/5W	Brake/tail light
	5627	R5W	Tail light and license plate light
	5637	R10W	Parking light
	3930	T4W	Park and position light
			15 A, 20 A, 30 A flat fuses

H7 ORIGINAL box – equipped with two H7 headlight lamps and contains the following double sets of the six most important spare lamps and three flat fuses.

Product Number: 4008321583215	Product Reference	ECE	i
	64215	H7	Headlight
	7511	P21W	Brake and tail light
	7510TSP	PY21W	Indicator light, amber
	7537	P21/5W	Brake/tail light
	5627	R5W	Tail light and license plate light
	5637	R10W	Parking light
	3930	T4W	Park and position light
			15 A, 20 A, 30 A flat fuses



Halogen lamps for motorcycles and scooters

Safety first



Drivers of motorized two-wheelers value OSRAM motorcycle lamps for their high performance and high vibration resistance proven in tests. Alongside increased safety, the OSRAM lamps from the design, performance, and original portfolio also offer bikers a wide variety of customization options.

Please see pages 18-28 for 12V range which is fitting for motorcycles.

OSRAM motorcycle lamps Vibration-resistant technology



Features

- OEM Quality
- Original spare parts that exceed all ECE minimum standards
- Wide product range

Benefits

- Tried and trusted in millions of vehicles of well-known manufacturers
- Premium quality
- Suitable for the most common headlights

OSRAM ORIGINAL product range

Product Reference	ECE	Product Number	V	W				No.
64326	S1	4052899157774	12	25/25	BA20d	1	100	32 ^{P.56}
64327	S2	4052899136755	12	35/35	BA20d	1	100	32 ^{P.56}
64327-01B	S2	4052899929692	12	35/35	BA20d	1	10	32 ^{P.56}
64185	HS1	4050300439969	12	35/35	PX43t	1	100	29 ^{P.56}
64185-01B	HS1	4052899253513	12	35/35	PX43t	1	10	29 ^{P.56}



Lamps for off-road use

Best light, even off-road¹⁾

In addition to robustness, resistance, and stability, off-road drivers above all want outstanding and reliable lighting performance. OSRAM offers a strong product range of off-road lamps with high wattage that impress with excellent brightness and high color temperature in absolutely any environment.



OSRAM SUPER BRIGHT PREMIUM¹⁾ / SUPER BRIGHT¹⁾

Extra power for off-road use



Features

- Extra power due to high wattage
- Excellent brightness
- Rugged and versatile

Benefits

- For the most difficult terrain: rescue services, construction and transport work, agriculture and forestry
- More light allows to see farther and therefore react sooner
- Solution for even the most unusual requirements

OSRAM SUPER BRIGHT PREMIUM¹⁾ / SUPER BRIGHT¹⁾ high-performance headlamps – product range

Product Reference		Product Number	V	W			
62200SBP	P14.5s (H1)	40528991 26282	12	100	1	100	5 ^{P.56}
62201SBP	PK22s (H3)	40528991 26312	12	100	1	100	6 ^{P.56}
62204SBP	P43t (H4)	400832 1856357	12	100/90	1	100	7 ^{P.56}
62261SBP	PX26d (H7)	400832 1856388	12	80	1	100	8 ^{P.56}
69005SBP	P20d (HB3)	400832 1888174	12	100	1	100	22 ^{P.56}
69006SBP	P22d (HB4)	400832 1888228	12	80	1	100	24 ^{P.56}
64152SB	PX14.5s	4050300 222738	12	100	1	100	5 ^{P.56}
64153SB	PKY22s	4050300 222837	12	100	1	100	6 ^{P.56}
64198SB	P45t (R2)	4050300 222028	12	60/55	1	100	30 ^{P.56}

¹⁾ These products do not have ECE approval and must not be used on public roads in any exterior application. Public roads use leads to cancellation of operating license and loss of insurance coverage. Several countries forbid sale and use of these products. Please contact your local distributor for further information.



OSRAM XENARC® COOL BLUE® BOOST¹⁾ / COOL BLUE® BOOST¹⁾

Hyper white light for off-road use



Features of XENARC® COOL BLUE® BOOST

- Hyper white light for LED look
- Color temperatures of up to 7,000 K²⁾
- Enhanced brightness

Benefits of XENARC® COOL BLUE® BOOST / COOL BLUE® BOOST

- Modern look
- High contrast
- More light allows to see farther and therefore react sooner



Features of COOL BLUE® BOOST

- Hyper white light for LED look
- Color temperatures of up to 5,500 K²⁾
- Enhanced brightness

OSRAM XENARC® COOL BLUE® BOOST¹⁾ high-performance headlamps – product range

Product Reference		Product Number	V	W			No.
66140CBB-HCB	PK32d-2 (D1S)	4052899 439184	85	35	2	4	1 ^{P.56}
66240CBB-HCB	P32d-2 (D2S)	4052899 441026	85	35	2	4	3 ^{P.56}
66340CBB-HCB	PK32d-5 (D3S)	4052899 527560	42	35	2	4	1 ^{P.56}
66440CBB-HCB	P32d-5 (D4S)	4052899 527522	42	35	2	4	3 ^{P.56}

OSRAM COOL BLUE® BOOST¹⁾ high-performance headlamps – product range

Product Reference		Product Number	V	W			No.
62150CBB-HCB	P14.5s (H1)	4052899 439764	12	80	2	10	5 ^{P.56}
62193CBB-HCB	P43t (H4)	4052899 439788	12	100/90	2	10	7 ^{P.56}
62210CBB-HCB	PX26d (H7)	4052899 439801	12	80	2	10	8 ^{P.56}
62211CBB-HCB	PGJ19-2 (H11)	4052899 439849	12	75	2	10	14 ^{P.56}

1) These products do not have ECE approval and must not be used on public roads in any exterior application. Public roads use leads to cancellation of operating license and loss of insurance coverage. Several countries forbid sale and use of these products. Please contact your local distributor for further information.

2) Measured in headlamps

Bringing style and performance to life

OSRAM LEDDriving[®] fixtures

Breathe new life into an old friend or take your custom car to the next level with OSRAM's industry-defining fixtures lighting solutions. Let us light your way, with award-winning headlight units, eye-catching dynamic mirror indicators and show-stopping tail lights – all in easy-to-fit and fully legal upgrade options.

OSRAM LEDDriving[®] headlights High efficiency meets extreme effectiveness



Features

- OSRAM full LED head light: LED position light, LED low beam, LED high beam, LED daytime running light and dynamic LED turn indicator
- High-performance long-life LEDs
- State-of-the art diffuser material
- Up to 200% more light¹⁾
- Up to 100% whiter light²⁾
- Up to 200 m long light beam
- Plug & Play installation
- ECE certified (ECE R6/R7/R48/R87/R112)
- IP protection class: IP69K

Benefits

- Upgrade to the latest OEM premium technology
- Linear and homogeneous light distribution
- Pixel-free optics
- Improved view for the driver and more visibility of your vehicle by other road users, resulting in increased road safety
- Quick and uncomplicated installation without modifying or damaging existing cables
- Completely legal in road traffic
- Resistant to water, dust, cold and warm temperatures, UV light and permanent vibrations & shocks
- 2-year guarantee³⁾

OSRAM LEDDriving[®] headlights for VW Golf VII as halogen replacement – product range

Product Reference	Product Number	V	W	K	l [mm]	w [mm]	h [mm]			No.
LEDHL103-GT ⁴⁾⁵⁾	4052899 599628	12	-	6,500	422	420	239	1	1	27 ^{P.51}
LEDHL103-CM ⁴⁾⁵⁾	4052899 599611	12	-	6,500	422	420	239	1	1	27 ^{P.51}
LEDHL103-CM RHD ⁵⁾⁶⁾	4062172 176026	12	-	6,500	422	420	239	1	1	27 ^{P.51}
LEDHL103-BK ⁴⁾⁵⁾	4052899 599598	12	-	6,500	422	420	239	1	1	27 ^{P.51}

1-6) Footnotes on page 37

OSRAM LEDriving® headlights for VW Golf VII as xenon replacement – product range

Product Reference	Product Number	V	W	K	l [mm]	w [mm]	h [mm]			No.
LEDHL104-GTI ⁽⁴⁾⁽⁵⁾	4052899604933	12	-	6,500	422	420	239	1	1	27 ^{P.51}
LEDHL104-CM ⁽⁴⁾⁽⁵⁾	4052899604919	12	-	6,500	422	420	239	1	1	27 ^{P.51}
LEDHL104-BK ⁽⁴⁾⁽⁵⁾	4052899604896	12	-	6,500	422	420	239	1	1	27 ^{P.51}



High Beam & Position Light



Low Beam & Position Light



Daytime Running Light



Position Light



Position Light & Indicator

OSRAM LEDriving® headlights for VW Golf VII Facelift as halogen replacement – product range

Product Reference	Product Number	V	W	K	l [mm]	w [mm]	h [mm]			No.
LEDHL109-BK LHD ⁽⁴⁾⁽⁵⁾	4062172169639	12	-	6,500	429	375	225	1	1	31 ^{P.51}
LEDHL109-GTI LHD ⁽⁴⁾⁽⁵⁾	4062172169622	12	-	6,500	429	375	225	1	1	31 ^{P.51}



Position Light



Daytime Running Light



Low Beam & Position Light



Indicator

OSRAM LEDriving® headlights for VW Amarok as halogen replacement – product range

Product Reference	Product Number	V	W	K	l [mm]	w [mm]	h [mm]			No.
LEDHL107-BK ⁽⁴⁾⁽⁵⁾	4052899616240	12	-	6,500	372	343	260	1	1	29 ^{P.51}
LEDHL107-BK RHD ⁽⁵⁾⁽⁶⁾	4062172176033	12	-	6,500	372	343	260	1	1	29 ^{P.51}



High Beam & Position Light

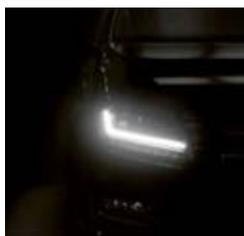

Daytime Running Light



Low Beam & Position Light



Position Light & Indicator

OSRAM LEDriving® headlights for BMW F20/21 as halogen replacement – product range

Product Reference	Product Number	V	W	K	I [mm]	W [mm]	h [mm]			No.
LEDHL108-BK ⁴⁾⁵⁾	4062172120333	12	-	6,500	425	460	245	1	1	30 ^{P,51}
LEDHL108-CM ⁴⁾⁵⁾	4062172120340	12	-	6,500	425	460	245	1	1	30 ^{P,51}



Position Light



Daytime Running Light

Low Beam &
Position LightHigh Beam &
Position Light

Indicator

OSRAM LEDriving® XENARC® headlights High efficiency meets extreme effectiveness



Features of LEDriving® XENARC® headlight for VW Golf VI

- Up to 70% more light¹⁾
- Up to 180 m long light beam
- Up to 40% whiter light²⁾
- Premium OSRAM quality available as GTI, BLACK and CHROME edition
- ECE certified with extra lifetime

Features of LEDriving® XENARC® headlight for Ford Focus 3

- Up to 70% more light¹⁾
- Up to 180 m long light beam
- Up to 40% whiter light²⁾
- Premium OSRAM quality
- ECE certified with extra lifetime

Benefits of LEDriving® XENARC® headlight for VW Golf VI and for Ford Focus 3

- More light allows to see farther and therefore react sooner thanks to pixel-free optic and state-of-the-art lightguide technology
- Better visibility due to daylight effect with easy plug & play installation without modifying or damaging existing cables
- High contrast and brilliantly cool white LED light for the most stylish look on the road
- 2-year guarantee³⁾
- No additional beam level adjustment and headlight cleaning system required, as well as no additional parts and no registration needed for installation

OSRAM LEDriving® XENARC® headlight for Ford Focus 3 – product range

Product Reference	Product Number	V	W	K	I [mm]	W [mm]	h [mm]			No.
LEDHL105 ⁴⁾⁷⁾	4052899600997	12	70	6,000	690	400	220	1	1	28 ^{P,51}

1) Compared to minimum ECE R112 requirements

2) Compared to standard headlights with halogen lamp

3) Refer to www.osram.com/am-guarantee for precise conditions

4) Not suitable for left-hand traffic

5) Refer to www.osram.com/am for detailed vehicle models

6) Suitable for left-hand traffic

7) Only suitable for VW Golf VI and Ford Focus 3 cars with OEM halogen headlight

OSRAM LEDriving® XENARC® headlight for VW Golf VI – product range

Product Reference	Product Number	V	W	K	l [mm]	w [mm]	h [mm]			
LEDHL102-GT ⁴⁾⁷⁾	4052899 982178	12	70	-	410	450	200	1	1	26 ^{P,51}
LEDHL102-CM ⁴⁾⁷⁾	4052899 982154	12	70	-	410	450	200	1	1	26 ^{P,51}
LEDHL102-BK ⁴⁾⁷⁾	4052899 982130	12	70	-	410	450	200	1	1	26 ^{P,51}
LEDHL102-BK RHD ⁶⁾⁷⁾	4052899 519411	12	70	-	410	450	200	1	1	26 ^{P,51}



Daytime Running Light



Position Light and Low Beam



Position Light and High Beam



Position Light and Indicator (Dynamic/Static)

4) 6) 7) Footnotes on page 37

OSRAM LEDriving® universal headlights

Universal headlight (12/24V) for multiple areas of applications



Features

- LED high & low beam (LEDUHL103/104)
- LED high & low beam with optional Position Light and Daytime Running Light (LEDUHL101/102)
- Universal mounting plate for several applications separately available
- IP Protection Class: IP69K
- ECE-Compliant
- 2-year guarantee¹⁾

Benefits

- Homogeneous light distribution
- Individual flexibility and a wide range of possible applications
- Pixel-free optics
- Improved view for the driver and more visibility of your vehicle
- Resistance to extreme external influences
- Available for RHD & LHD vehicles

OSRAM LEDriving® universal headlights – product range

Product Reference	Product Number	V	W	K	l [mm]	w [mm]	h [mm]			
LEDUHL101 ²⁾	4062172219358	12/24	34	5,400-6,500	142	112	152	1	4	5 ^{P.54}
LEDUHL102 ³⁾	4062172239011	12/24	34	5,400-6,500	142	112	152	1	4	5 ^{P.54}
LEDUHL103 ²⁾	4062172219556	12/24	28	5,400-6,500	142	112	152	1	4	5 ^{P.54}
LEDUHL104 ³⁾	4062172238991	12/24	28	5,400-6,500	142	112	152	1	4	5 ^{P.54}
Mounting Kit										
LEDUHL MOUNT101	4062172302449	-	-	-	-	-	-	1	10	5 ^{P.54}



4-Function: High Beam, Low Beam, Daytime Running Light, Position Light, LHD & RHD



2-Function: High Beam and Low Beam, LHD & RHD

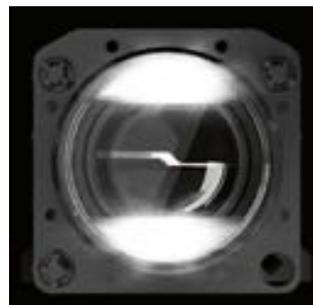

Position Light and Daytime Running Light

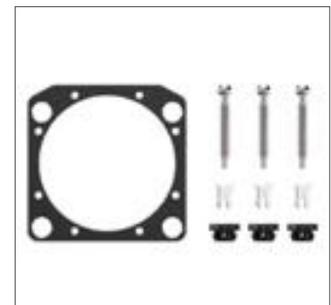

Mounting Kit

1) Please refer to osram.com/guarantee for precise conditions

2) Suitable for left hand drive

3) Suitable for right hand drive

OSRAM LEDriving® dynamic mirror indicators

Individual design meets innovative lighting technology



Features

- Fully dynamic LEDriving® mirror indicator
- High-performance long-life LEDs
- Plug & Play Installation
- Black & White Edition
- ECE certified (ECE R6/R10)
- State-of-the-art light guide technology
- IP-Protection Class IP6K9K
- 5-year guarantee¹⁾

Benefits

- Up to 200% more brightness²⁾
- High contrast day and night due to intensive yellow LED light³⁾
- Improved visibility of your vehicle by other road users, resulting in increased road safety
- Quick and uncomplicated installation without modifying or damaging existing cables
- Tinted black design & clear white design
- Completely legal in road traffic
- Linear and homogeneous light distribution
- Resistant to water, dust, cold and warm temperatures, UV light and permanent vibrations & shocks

OSRAM LEDriving® Dynamic Mirror Indicator for VW Golf VII – product range

Product Reference	Product Number	V	W	K	l (mm)	w (mm)	h (mm)	Light Guide	Mounting	Light No.
LEDDMI 5G0 WT S ⁴⁾	4062172 046534	12	2.4	2,700	280	70	50	1	4	32 ^{P.51}
LEDDMI 5G0 BK S ⁴⁾	4062172 046510	12	2.4	2,700	280	70	50	1	4	32 ^{P.51}



OSRAM LEDriving® Dynamic Mirror Indicator for VW Golf VI – product range

Product Reference	Product Number	V	W	K	l (mm)	w (mm)	h (mm)	Light Guide	Mounting	Light No.
LEDDMI 5K0 WT S ⁴⁾	4062172 149105	12	4.9	2,700	212	97	74	1	4	35 ^{P.51}
LEDDMI 5K0 BK S ⁴⁾	4062172 149082	12	4.9	2,700	212	97	74	1	4	35 ^{P.51}



OSRAM LEDriving® Dynamic Mirror Indicator for VW Passat B8 – product range

Product Reference	Product Number	V	W	K	$\frac{l}{[mm]}$	$\frac{w}{[mm]}$	$\frac{h}{[mm]}$			 No.
LEDDMI 3G0 WT S ⁴⁾	4062172046497	12	2.4	2,700	255	80	60	1	4	33 ^{P.51}



OSRAM LEDriving® Dynamic Mirror Indicator for BMW F20 – product range

Product Reference	Product Number	V	W	K	$\frac{l}{[mm]}$	$\frac{w}{[mm]}$	$\frac{h}{[mm]}$			 No.
LEDDMI F20 WT S ⁴⁾	4062172051286	12	4.56	2,700	220	55	74	1	4	34 ^{P.51}
LEDDMI F20 BK S ⁴⁾	4062172052795	12	4.56	2,700	220	55	74	1	4	34 ^{P.51}



OSRAM LEDriving® Dynamic Mirror Indicator for Seat Leon 5F – product range

Product Reference	Product Number	V	W	K	$\frac{l}{[mm]}$	$\frac{w}{[mm]}$	$\frac{h}{[mm]}$			 No.
LEDDMI 5F0 WT S ⁴⁾	4062172052757	12	2.4	2,700	237	54	50	1	4	38 ^{P.51}
LEDDMI 5F0 BK S ⁴⁾	4062172052832	12	2.4	2,700	237	54	50	1	4	38 ^{P.51}



Check the compatibility of your car!

Vehicle Finder: https://www.osram.com/am/dmi_vehiclefinder.jsp



1) Refer to www.osram.com/am-guarantee for precise conditions | 2) Compared to the minimum ECE R6 requirements | 3) Compared to other mirror indicators | 4) For precise car models please refer to www.osram.com/am

OSRAM LEDriving® Dynamic Mirror Indicator for Audi A4 B9 – product range

Product Reference	Product Number	V	W	K	L [mm]	W [mm]	h [mm]			Light No.
LEDDMI 8W0 WT S ¹⁾	4062172052733	12	2.4	2,700	255	65	69	1	4	36 ^{P.51}
LEDDMI 8W0 BK S ¹⁾	4062172052818	12	2.4	2,700	255	65	69	1	4	36 ^{P.51}



OSRAM LEDriving® Dynamic Mirror Indicator for Audi A3 8V – product range

Product Reference	Product Number	V	W	K	L [mm]	W [mm]	h [mm]			Light No.
LEDDMI 8V0 WT S ¹⁾	4062172052771	12	2.4	2,700	242	56	70	1	4	37 ^{P.51}
LEDDMI 8V0 BK S ¹⁾	4062172052856	12	2.4	2,700	242	56	70	1	4	37 ^{P.51}



OSRAM LEDriving® tail lights

Putting your car's rear out in front



Features

- OSRAM LED-tail lights
- LED position light, LED stop light, LED dynamic turn indicator
- High-performance long-life LEDs
- State-of-the-art diffuser material
- Up to 80% less energy consumption²⁾
- No delayed response of the illumination
- Easy and quick plug & play installation
- IP Protection class: IP69K
- ECE certified (ECE R6/R7/R10/R23)
- 2-year guarantee³⁾

Benefits

- Upgrade to the latest OEM premium technology
- Excellent light distribution within the tail light
- Extremely high efficiency and effectiveness
- Improved visibility and therefore increased safety on the road
- No modification or damaging of existing cables
- Resistance to water, dust, vibration, shocks and hot & cold temperature
- No registration in the vehicle documents necessary

1) For precise car models please refer to www.osram.com/am

2) Compared to standard tail lights with halogen lamp

3) Refer to www.osram.com/am-guarantee for precise conditions

OSRAM LEDriving® tail lights for VW Golf VI – product range

Product Reference	Product Number	V	W	K	l (mm)	w (mm)	h (mm)			No.
LEDTL102-CL	4052899617001	12	30	-	480	205	280	1	1	40 ^{P.51}



Stop Light & Position Light



Position Light & Indicator



Rear Fog Light & Position Light



Position Light

OSRAM LEDriving® tail lights for Ford Fiesta MK7 – product range

Product Reference	Product Number	V	W	K	l (mm)	w (mm)	h (mm)			No.
LEDTL101-CL	4052899616257	12	27	-	361	254	400	1	1	39 ^{P.51}



Stop Light & Position Light

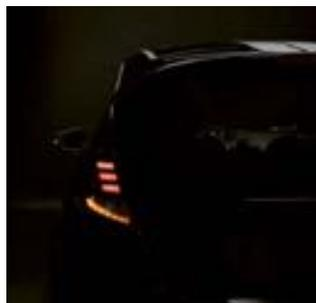

Position Light & Indicator

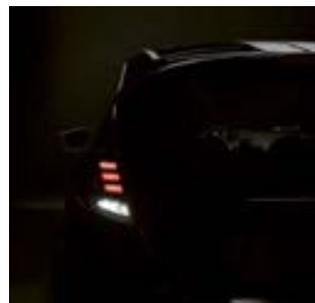

Position Light & Reverse Light

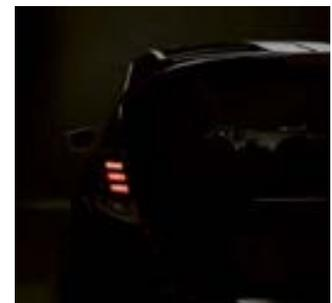

Position Light

Bringing light to life on-road or off-road

OSRAM LEDDriving[®] driving and working lights

OSRAM re-writes the rules for what you can expect from your vehicle. Now, a variety of performances, shapes and beam patterns let you bring intense white LED light to the darkest corners of the world, at work or at play. There are six series to choose from: functional, multifunctional, slim, value, professional and accessories.



OSRAM LEDDriving[®] driving lights¹⁾

Powerful performance and versatile applications



ECE
compliant



Features

- ECE-Certification
- High-performance long-life LEDs
- Up to 5,000h lifetime
- Shatterproof polycarbonate lens
- Integrated driver
- Integrated thermal management system
- Various shapes & beam patterns
- Highest IP-Protection Classes: IP67/IP69K

Benefits

- No registration in the car documents required
- ECE-Certified
- Linear and homogeneous light distribution
- Improved view and visibility day & night resulting in increased safety
- Lightweight and at the same time robust and resistant
- Protection against overheating
- Powerful far & near field illumination
- Resistant to extreme external influences regarding water, dust, impacts, heat & cold and permanent vibration & shocks

Functional series product range – OSRAM LED driving lights

Product Reference	Product Number	V	W	K	l (mm)	w (mm)	h (mm)			No.
LEDDL103-SP ¹⁾	4052899595330	12/24	35	6,000	309	93,5	54	1	4	43 ^{P.51}
LEDDL103-CB ¹⁾	4052899595354	12/24	35	6,000	309	93,5	54	1	4	43 ^{P.51}
LEDDL104-SP ¹⁾	4052899595378	12/24	36	6,000	564	93,5	54	1	4	44 ^{P.51}
LEDDL104-CB ¹⁾	4052899595392	12/24	68	6,000	564	93,5	54	1	4	44 ^{P.51}
LEDDL104-CB SM ²⁾	4052899614079	12/24	68	6,000	564	93,5	54	1	4	44 ^{P.51}

Slim series product range – OSRAM LED driving lights

Product Reference	Product Number	V	W	K	l [mm]	w [mm]	h [mm]			No.
LEDDL105-SP ¹⁾	4052899 595415	12/24	14	6,000	182	63,5	38	1	8	45 ^{P.51}
LEDDL106-SP ¹⁾	4052899 595439	12/24	29	6,000	350	63,5	38	1	4	1 ^{P.52}
LEDDL106-CB ¹⁾	4062172 142083	12/24	29	6,000	350	61,5	38	1	4	1 ^{P.52}
LEDDL107-SP ¹⁾	4052899 595453	12/24	46	6,000	556	63,5	38	1	4	2 ^{P.52}
LEDDL107-CB ¹⁾	4062172 142106	12/24	44	6,000	556	61,5	38	1	4	2 ^{P.52}

Multifunctional series product range – OSRAM LED driving lights

Product Reference	Product Number	V	W	K	l [mm]	w [mm]	h [mm]			No.
LEDDL102-SP ¹⁾	4052899 595293	12/24	30/2	6,000	140	69,2	67	1	8	42 ^{P.51}
LEDDL110-CB ¹⁾	4062172 153959	12/24	45/1	6,000	390	86	54	1	4	5 ^{P.52}
LEDDL111-CB ¹⁾	4062172 153973	12/24	39/1	6,000	176	126	201	1	4	6 ^{P.52}
LEDDL112-CB ¹⁾	4062172 153997	12/24	60/2.5	6,000	261	251	150	1	2	7 ^{P.52}
LEDDL113-CB ¹⁾	4062172 154017	12/24	70/1.5	6,000	241	169	134	1	2	8 ^{P.52}

Value series product range – OSRAM LED driving lights

Product Reference	Product Number	V	W	K	l [mm]	w [mm]	h [mm]			No.
LEDDL115-SP ¹⁾	4062172 141888	12/24	27	6,000	275	67	36	1	4	9 ^{P.52}
LEDDL116-SP ¹⁾	4062172 141918	12/24	63	6,000	526	67	36	1	4	10 ^{P.52}
LEDDL117-CB ¹⁾	4062172 141932	12/24	30	6,000	306	62	74	1	4	11 ^{P.52}
LEDDL118-CB ¹⁾	4062172 141956	12/24	55	6,000	582	62	74	1	4	12 ^{P.52}
LEDDL119-WD ¹⁾	4062172 150712	12/24	22	6,000	83	65	108	1	8	13 ^{P.52}
LEDDL120-CB SM ¹⁾	4062172 232159	12/24	108	6,000	1031	67	35	1	4	14 ^{P.52}
LEDDL108-WD ¹⁾	4062172 105712	12/24	15	6,000	121	48	131	1	8	3 ^{P.52}
LEDDL109-WD ¹⁾	4062172 105736	12/24	15	6,000	113	56	127	1	8	4 ^{P.52}

Accessory series product range – OSRAM LED driving and working lights³⁾

Product Reference	Product Number	V	W	K	l [mm]	w [mm]	h [mm]			No.
LEDDL ACC 101 ¹⁾	4062172 147682	12	-	-	-	-	-	1	8	15 ^{P.52}
LEDDL ACC 102 ¹⁾	4062172 147729	12	-	-	-	-	-	1	8	16 ^{P.52}
LEDDL ACC 103 ¹⁾	4062172 147705	12	-	-	686	71	93	1	6	17 ^{P.52}
LEDPWL ACC 101	4062172 294768	12	-	-	43	35	45	1	30	2 ^{P.54}
LEDPWL ACC 102	4062172 294782	12	-	-	35	123.25	88	1	30	3 ^{P.54}
LEDPWL ACC 103	4062172 294805	12	-	-	3000	30	5	1	30	4 ^{P.54}

1) Special mounting regulations apply | 2) Single Mount (SM), does not need to be installed in pairs for 12/24 V-vehicles | 3) Accessories for working lights

OSRAM LEDriving® working lights

Professional light for professional work



Features

- High-performance long-life LEDs
- Up to 5,000 h lifetime
- Shatterproof polycarbonate lens
- Integrated driver
- Integrated thermal management system
- Powerful far & near field illumination
- Various beam angles
- Highest IP-Protection Classes: IP67/IP69K

Benefits

- Linear and homogeneous light distribution
- Improved view and visibility day & night resulting in increased safety for you and others
- Lightweight and at the same time robust and resistant
- Protection against overheating
- Powerful far & near field illumination
- Resistant to extreme external influences regarding water, dust, impacts, heat & cold and permanent vibration & shocks

Multifunctional series product range – OSRAM LED working lights

Product Reference	Product Number	V	W	K	l [mm]	w [mm]	h [mm]			Light No.
LEDDL101-SP	4052899 595255	12	22/2	6,000	85	57	121,5	1	8	41 ^{P.51}
LEDDL101-WD	4052899 595279	12	22/2	6,000	85	57	121,5	1	8	41 ^{P.51}
LEDDL102-WD	4052899 595316	12/24	30/2	6,000	140	69,2	67	1	8	42 ^{P.51}

Value series product range – OSRAM LED working lights

Product Reference	Product Number	V	W	K	l [mm]	w [mm]	h [mm]			Light No.
LEDWL101-SP	4062172 141970	12/24	20	6,000	80	70	85	2	16	18 ^{P.52}
LEDWL102-SP	4062172 150699	12/24	8	6,000	75	30	93	2	16	19 ^{P.52}
LEDWL103-WD	4062172 142021	12/24	8	6,000	73	31	97	2	16	20 ^{P.53}

Professional series product range – OSRAM LED working lights

Product Reference	Product Number	V	W	K	l [mm]	w [mm]	h [mm]			Light No.
LEDPWL 101-UW	4062172 279406	12/24	27	6,000	117.1	68.4	113.42	1	10	23 ^{P.53}
LEDPWL 102-UW	4062172 279420	12/24	33	6,000	117.1	68.4	113.42	1	10	24 ^{P.53}
LEDPWL 103-UW	4062172 279444	12/24	45	6,000	117.1	68.4	113.42	1	10	25 ^{P.53}
LEDPWL 104-WD	4062172 279468	12/24	27	6,000	117.1	68.4	113.42	1	10	26 ^{P.53}
LEDPWL 105-WD	4062172 279482	12/24	33	6,000	117.1	68.4	113.42	1	10	27 ^{P.53}
LEDPWL 106-WD	4062172 279505	12/24	45	6,000	117.1	68.4	113.42	1	10	28 ^{P.53}
LEDPWL 107-FL	4062172 279529	12/24	27	6,000	117.1	68.4	113.42	1	10	29 ^{P.53}
LEDPWL 108-FL	4062172 279543	12/24	33	6,000	117.1	68.4	113.42	1	10	30 ^{P.53}
LEDPWL 109-FL	4062172 279567	12/24	45	6,000	117.1	68.4	113.42	1	10	31 ^{P.53}
LEDPWL 110-SP	4062172 279581	12/24	27	6,000	117.1	68.4	113.42	1	10	32 ^{P.53}
LEDPWL 111-SP	4062172 279604	12/24	33	6,000	117.1	68.4	113.42	1	10	33 ^{P.53}
LEDPWL 112-SP	4062172 279628	12/24	45	6,000	117.1	68.4	113.42	1	10	34 ^{P.53}
LEDPWL 113-UW	4062172 279642	12/24	15	6,000	117.1	68.4	113.42	1	10	35 ^{P.53}
LEDPWL 114-WD	4062172 279666	12/24	15	6,000	117.1	68.4	113.42	1	10	36 ^{P.53}
LEDPWL 115-FL	4062172 279680	12/24	15	6,000	117.1	68.4	113.42	1	10	37 ^{P.53}
LEDPWL 116-SP	4062172 279703	12/24	15	6,000	117.1	68.4	113.42	1	10	1 ^{P.54}

OSRAM LEDriving® daytime running lights

Stylish highlights for state-of-the-art headlights



Features of LG (LEDDRL102)

- Lightguide technology for homogeneous light distribution
- LED daytime running light including position light
- Color temperatures of up to 6,000 K
- Premium OSRAM quality
- OEM technology with long lifetime of up to 5,000 h and low energy consumption

Benefits of LG (LEDDRL102)

- Pixel-free brilliance and dynamic curves
- Dimmable light functions
- Perfect color match for existing HID and LED systems with cool white and stylish LED light
- 5-year guarantee¹⁾
- Simple installation and compatible with start-stop system and hybrid vehicles

Features of PX-5 (LEDDRL301 CL15)

- Faceted optic and dotted pixel technology
- LED daytime running light (ECE certified)
- Color temperatures of up to 5,200 K
- Premium OSRAM quality
- Long lifetime of up to 5,000 h with low energy consumption

Benefits of PX-5 (LEDDRL301 CL15)

- Dynamic appearance of the daytime running lights
- Legal LED upgrade by improving both visibility and style
- Perfect color match for existing HID and LED systems with cool white and stylish LED light
- 3-year guarantee¹⁾
- Simple installation

OSRAM LEDriving® daytime running light product range

Product Reference	Product Number	V	W	K	l ³⁾ [mm]	w ³⁾ [mm]	h ³⁾ [mm]			No.
LEDDRL102 ²⁾	4052899 200494	12	15	6,000	167	42	32	1	4	21 ^{P.53}
LEDDRL301 CL15 ²⁾	4052899 170766	12	13.5	5,200	160	30	23	1	5	22 ^{P.53}

1) Refer to www.osram.com/am-guarantee for precise conditions

2) Compatible with start-stop-system and hybrid vehicles

3) Product measurements

OSRAM LEDambient®¹⁾ Stylish interior ambient lighting



Features of LEDambient® TUNING LIGHTS

- Flexible 16-color LED strips with adhesive backing
- Providing RGB styling to the interior of the vehicle
- 24-button wireless remote control
- OSRAM quality
- Adapter included for auto accessory plug-in

Benefits of LEDambient® TUNING LIGHTS

- 4 flashing modes
- Dimmable
- Compact device for user-friendly operation
- 2-year guarantee²⁾
- Extension kit available

Features of LEDambient® INTERIOR STRIP KIT

- High brightness thanks to 90 LEDs per 1.5 m strip
- White light with color temperature up to 4,500 K
- Two flexible self-adhesive LED strips of 1.5 m
- OSRAM quality
- Two strips per packaging, individually shortenable after every 3rd LED

Benefits of LEDambient® INTERIOR STRIP KIT

- Illuminate every corner of your car, commercial vehicle or caravan
- Interior lighting for the vehicle roof, loading area, trunk or other cabinet lighting application
- Easy to install with no soldering or use of screws
- 2-year guarantee²⁾
- Individual length adjustment for various application purposes

OSRAM LEDambient® TUNING LIGHTS¹⁾ product range

Product Reference	Product Number	V	COLOR	KIT			No.
LEDINT201	40528999 33576	12	Multicolor	Base Kit	1	2	-
LEDINT201-SEC	4052899 248809	12	Multicolor	Base Kit	1	2	-
LEDINT202 ³⁾	4052899 933590	12	Multicolor	Extension Kit	1	2	-

OSRAM LEDambient® INTERIOR STRIP KIT¹⁾ product range

Product Reference	Product Number	V	COLOR	KIT			No.
LEDINT203	40528995 16670	12	White color	-	1	2	22 ^{P.55}

1) These products do not have ECE approval and must not be used on public roads in any exterior application. Public roads use leads to cancellation of operating license and loss of insurance coverage. Several countries forbid sale and use of these products. Please contact your local distributor for further information.

2) Refer to www.osram.com/am-guarantee for precise conditions

3) Only works in combination with the base kit

Tools for all requirements

Practical support in everyday life



Benefits of Automotive Lamp Cabinet

- Clear lamp arrangement
- Slot system for easy removal
- Drawers for additional lamps
- Lamp tester optionally available
- Available with or without lock

Benefits of MINIWATT® 12V assortment box

- 17 different MINIWATT® 12V lamps for passenger cars (total of 180 lamps), highlighted in color
- Equipment overview with the most important technical data directly in the box

OSRAM Automotive Lamp Cabinet | OSRAM MINIWATT® 12V

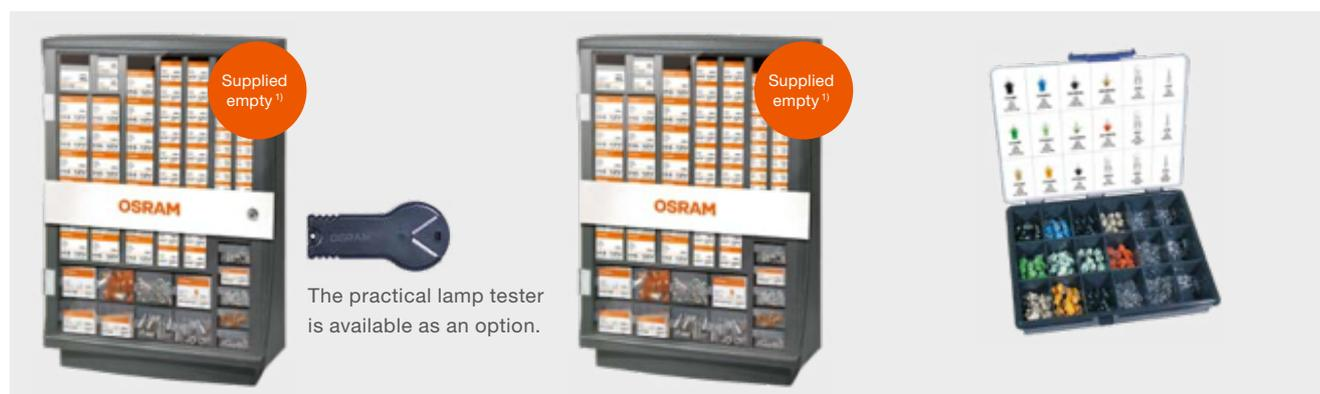

Product Reference	Product Number	Dimensions (W x H x D)	Contents	
ALC without ¹⁾	4008321694355	405 x 572 x 190 mm	-	-
ALC with lock ¹⁾	4008321694362	405 x 572 x 190 mm	-	-
Lamp tester 50X1	4008321786951	-	-	-
509961	4008321082169	240 x 43 x 190 mm	180 lamps	3

1) We are happy to provide you with a proposal of stock. Please contact your local representative.

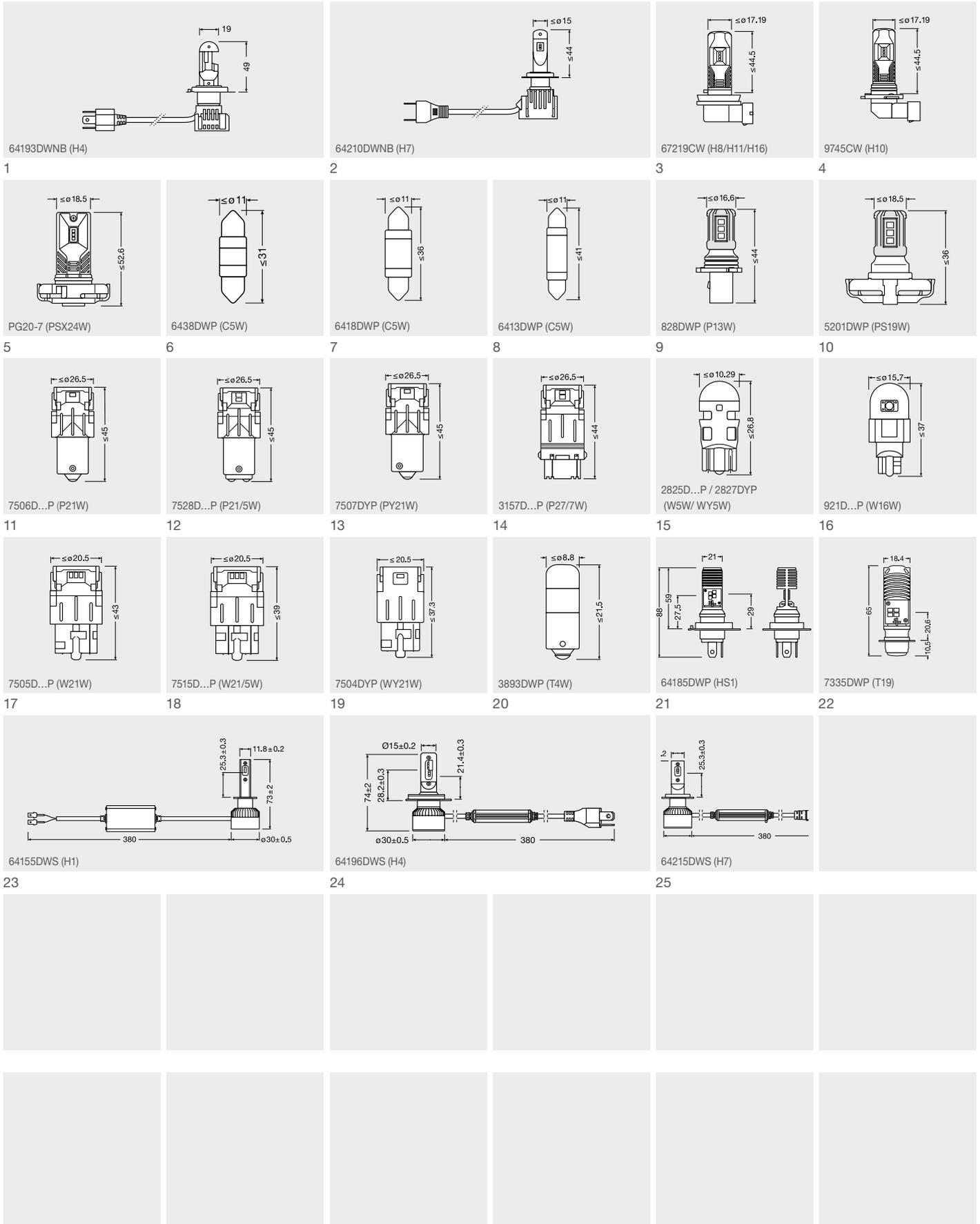

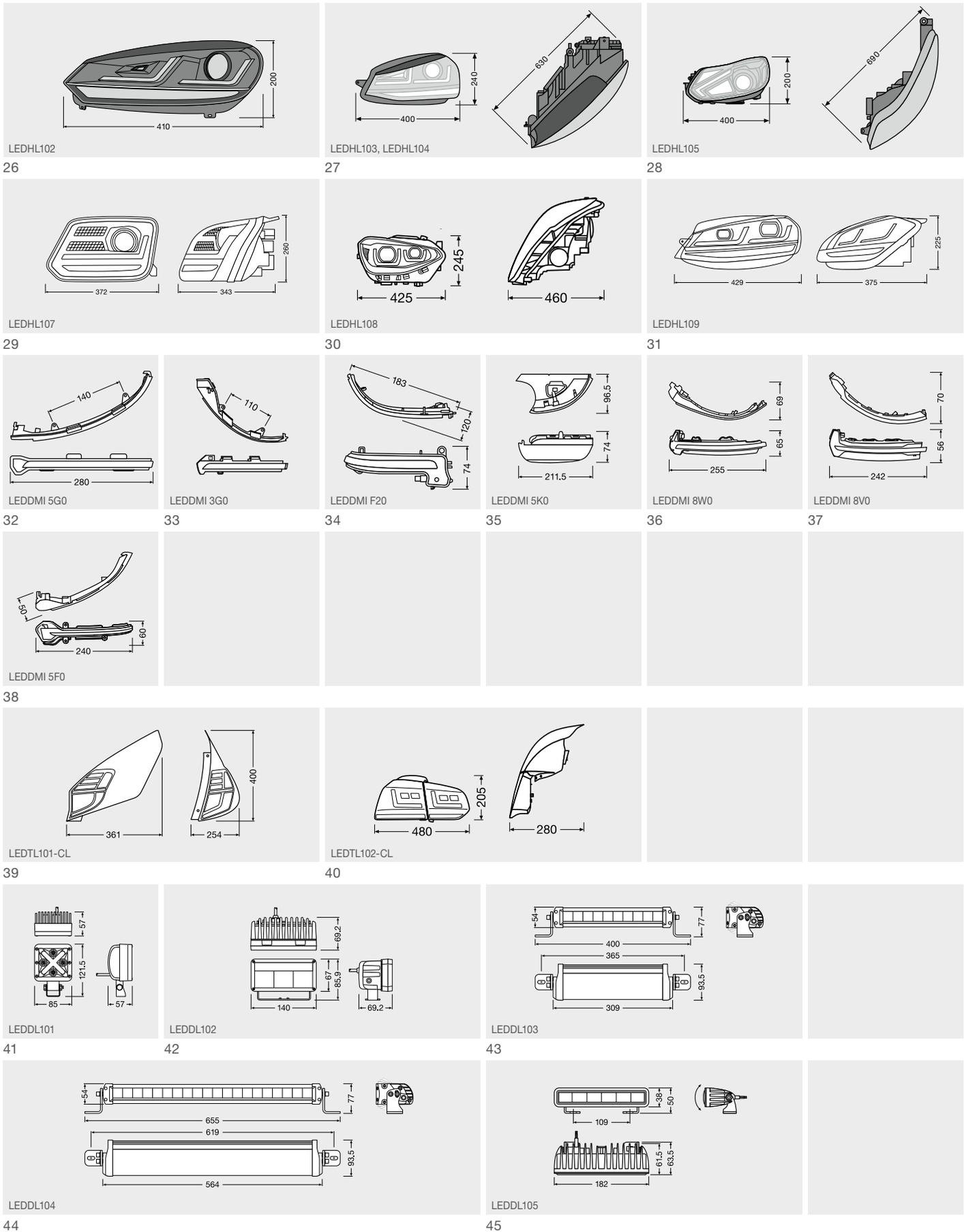

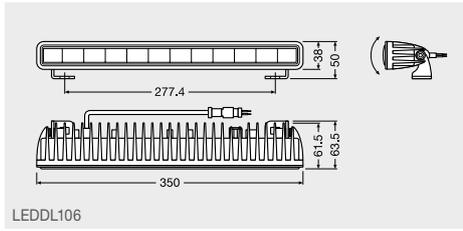

LEDDL106

1

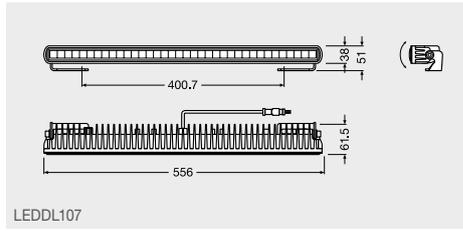

LEDDL107

2

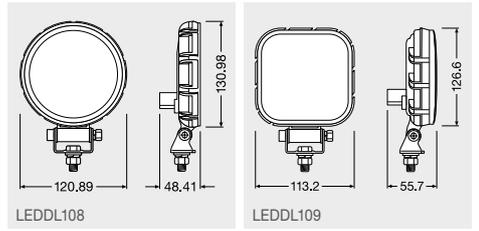

LEDDL108

LEDDL109

3

4

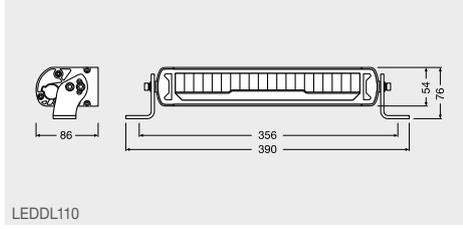

LEDDL110

5

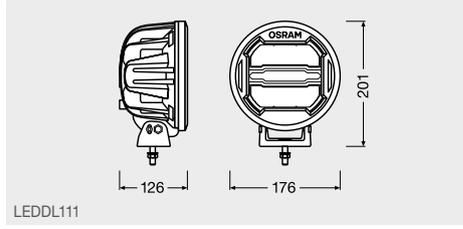

LEDDL111

6

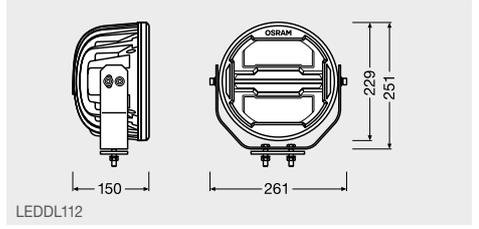

LEDDL112

7

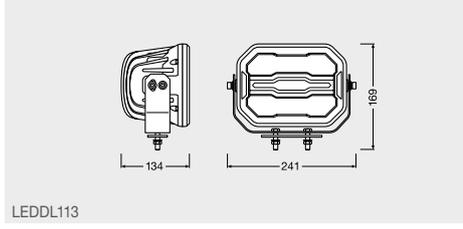

LEDDL113

8

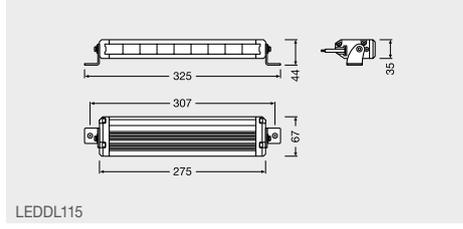

LEDDL115

9

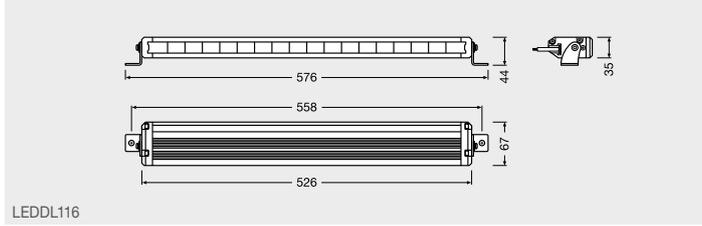

LEDDL116

10

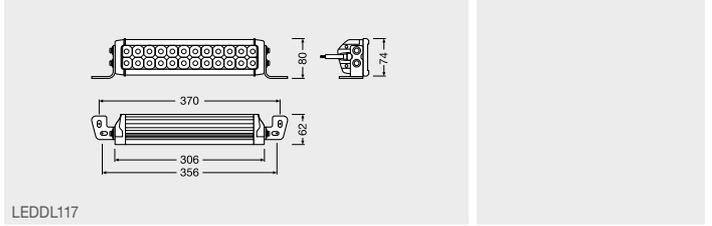

LEDDL117

11

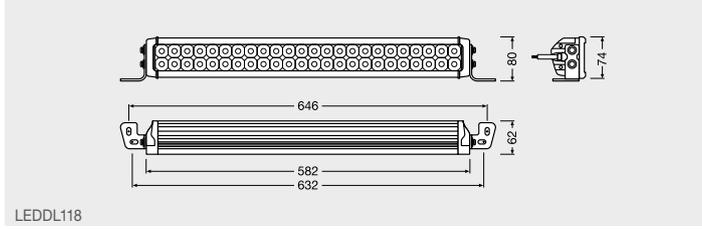

LEDDL118

12

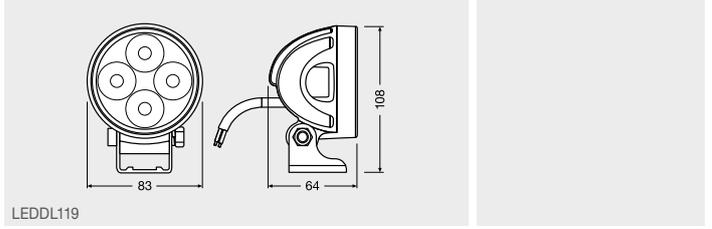

LEDDL119

13

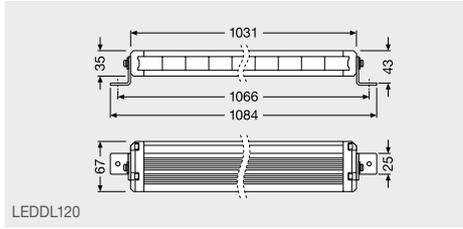

LEDDL120

14

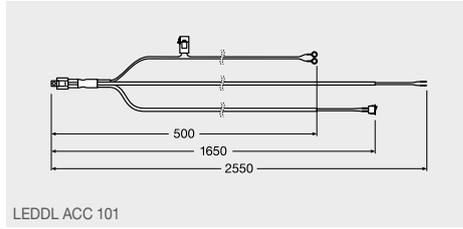

LEDDL ACC 101

15

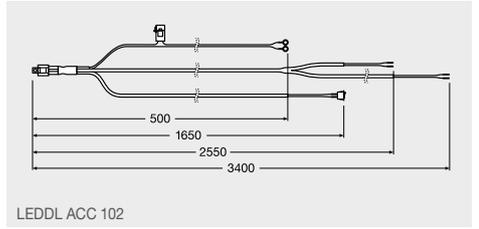

LEDDL ACC 102

16

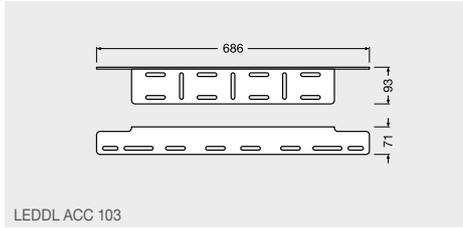

LEDDL ACC 103

17

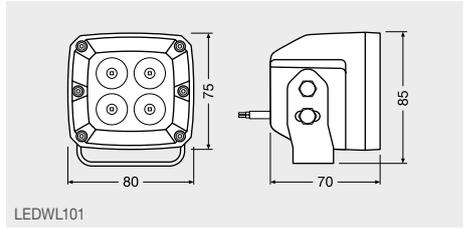

LEDWL101

18

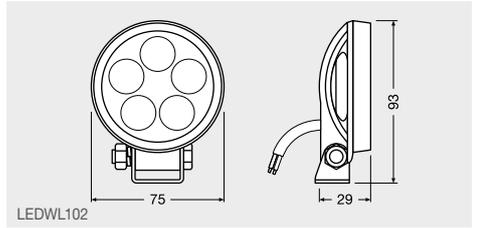

LEDWL102

19

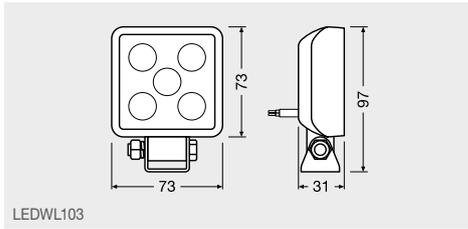

LEDWL103

20

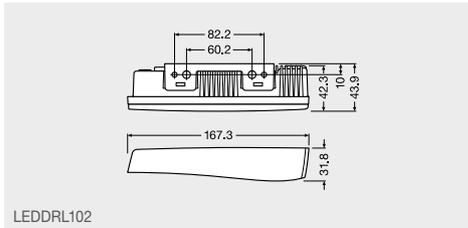

LEDDRL102

21

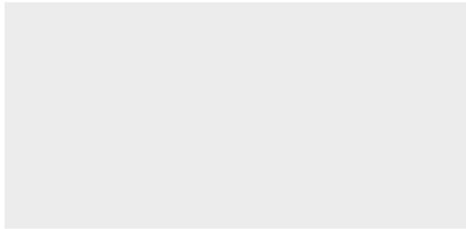

LEDDRL301

22

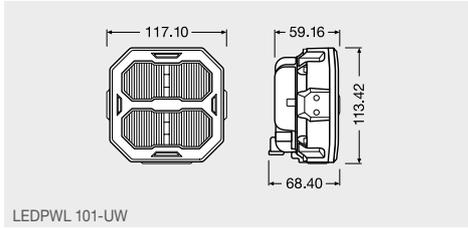

LEDPWL 101-UW

23

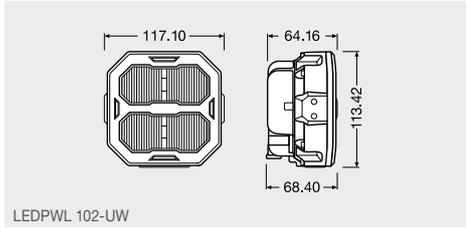

LEDPWL 102-UW

24

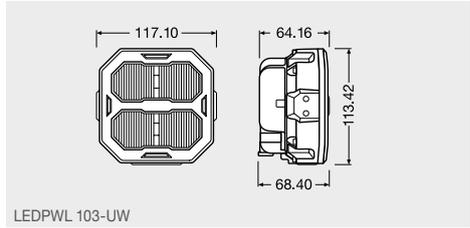

LEDPWL 103-UW

25

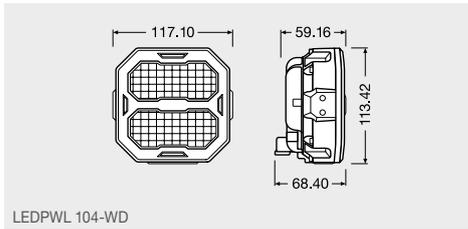

LEDPWL 104-WD

26

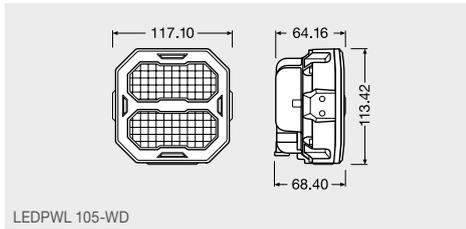

LEDPWL 105-WD

27

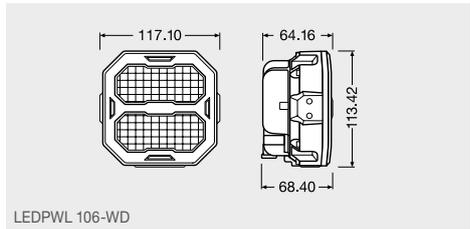

LEDPWL 106-WD

28

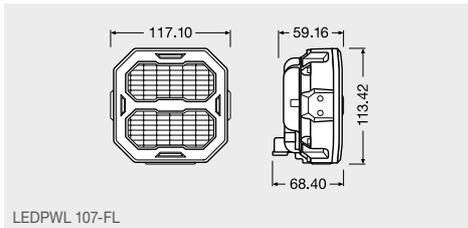

LEDPWL 107-FL

29

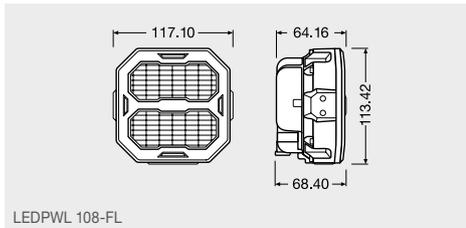

LEDPWL 108-FL

30

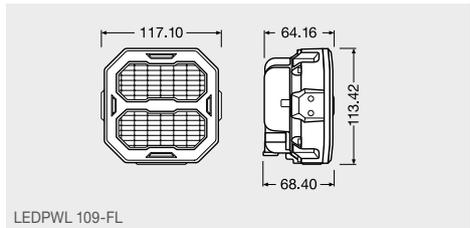

LEDPWL 109-FL

31

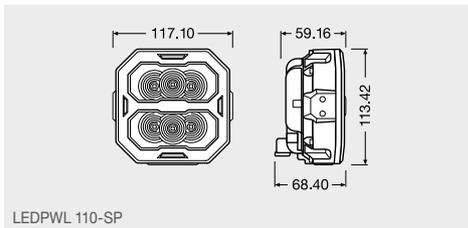

LEDPWL 110-SP

32

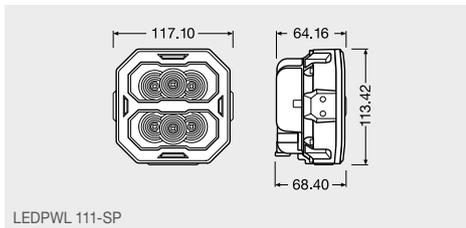

LEDPWL 111-SP

33

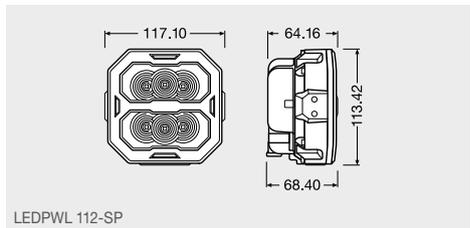

LEDPWL 112-SP

34

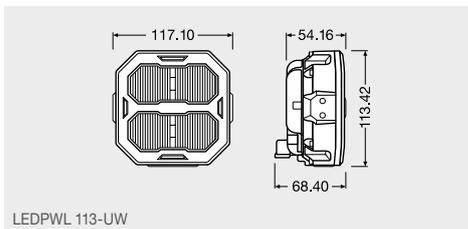

LEDPWL 113-UW

35

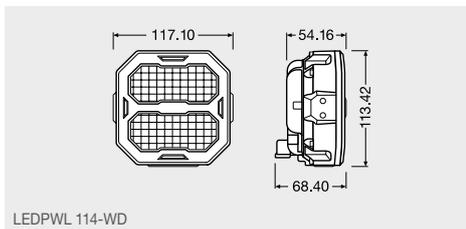

LEDPWL 114-WD

36

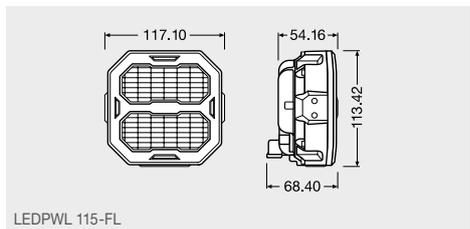

LEDPWL 115-FL

37

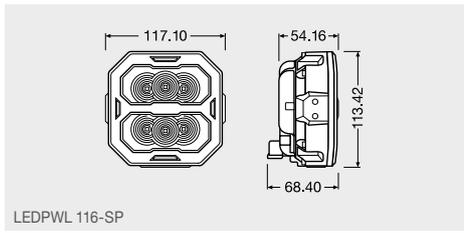

1

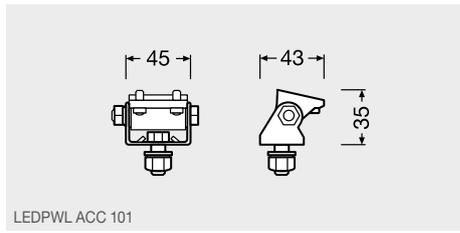

2

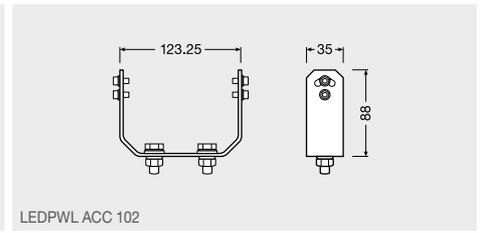

3

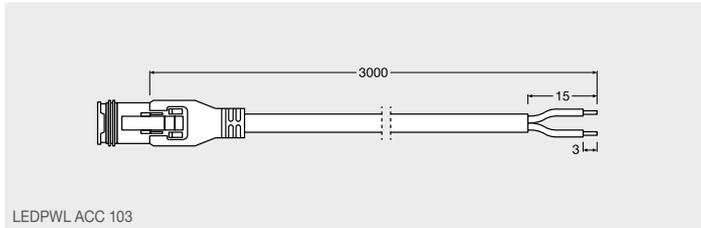

4

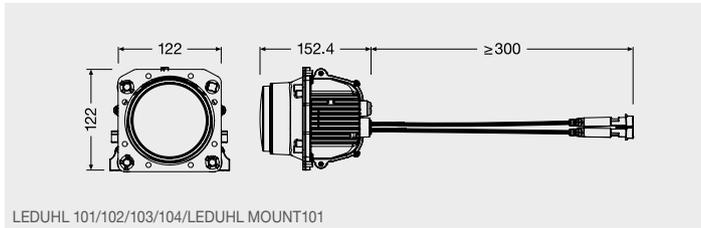

5

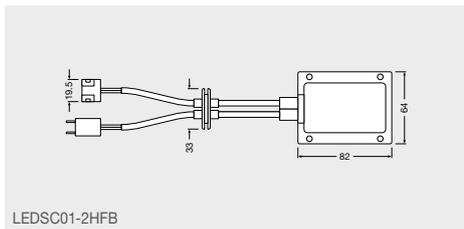

6

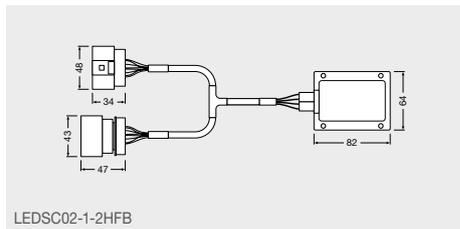

7

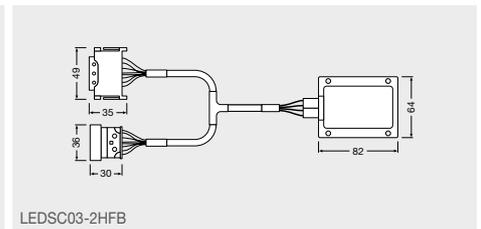

8

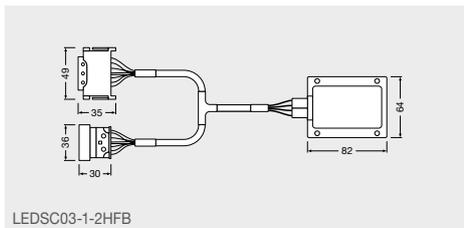

9

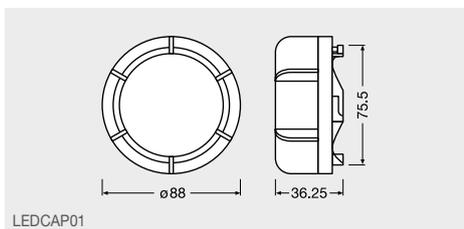

10

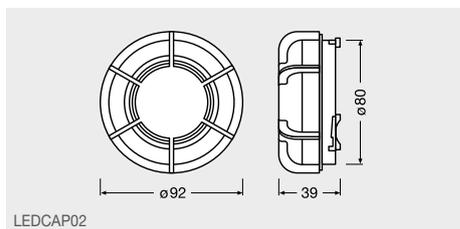

11

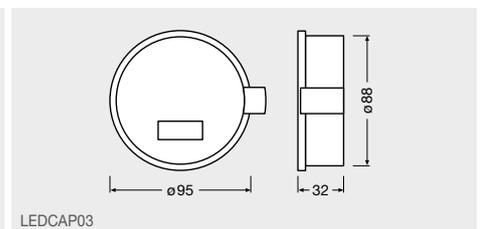

12

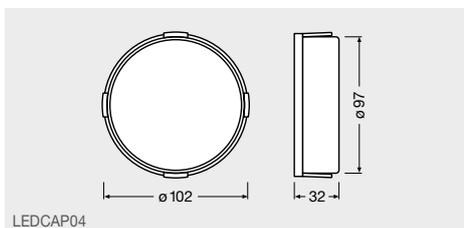

13

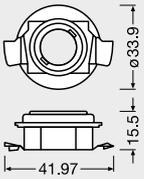
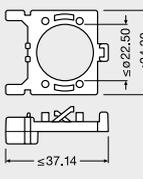
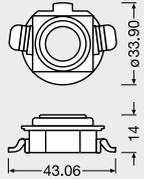
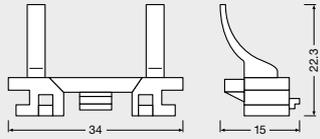
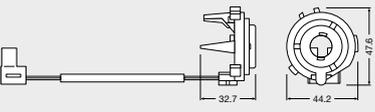
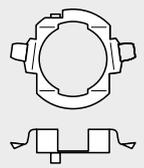
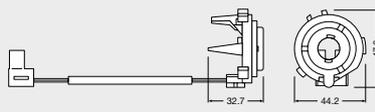
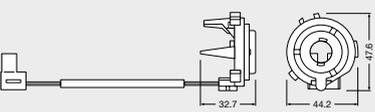
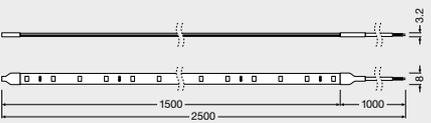
 <p>64210DA01-1</p>	 <p>64210DA02</p>	 <p>64210DA03-1</p>	 <p>64210DA04</p>	
<p>14</p>	<p>15</p>	<p>16</p>	<p>17</p>	
 <p>64210DA05</p>	 <p>64210DA06</p>	 <p>64210DA07</p>		
<p>18</p>	<p>19</p>	<p>20</p>		
 <p>64210DA08</p>				
<p>21</p>				
 <p>LEDINT203</p>				
<p>22</p>				

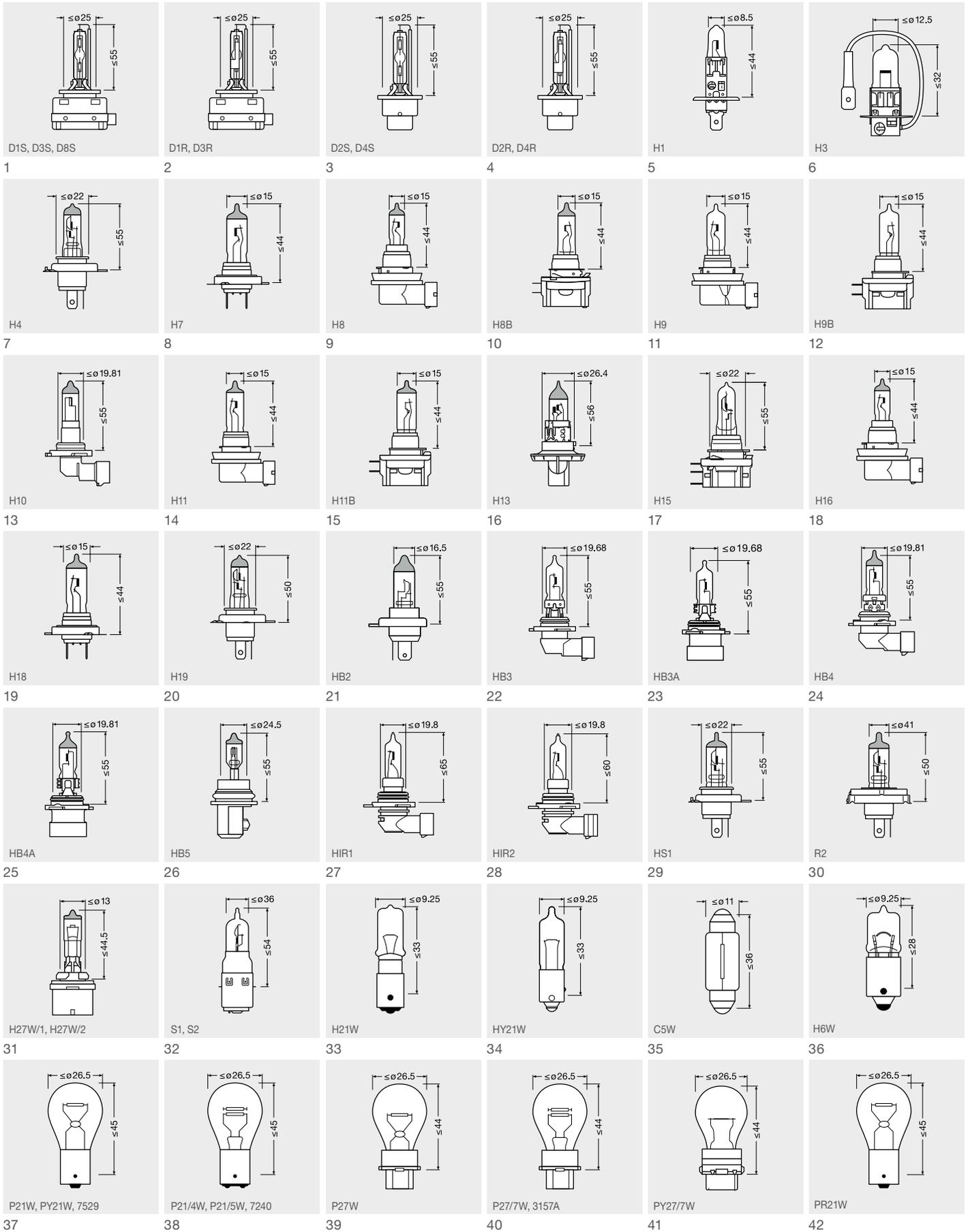

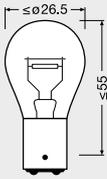
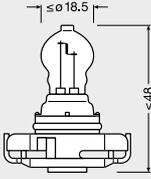
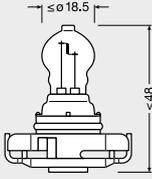
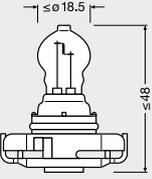
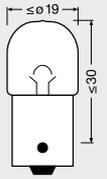
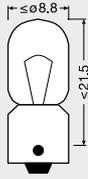
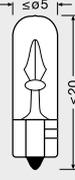
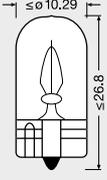
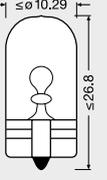
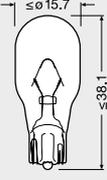
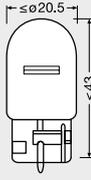
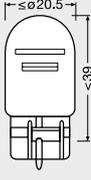
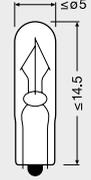
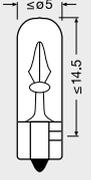
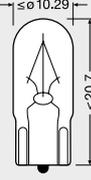
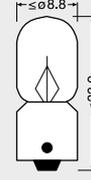
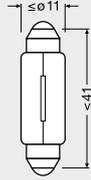
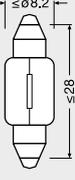
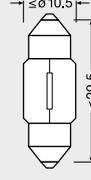
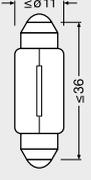
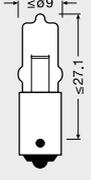
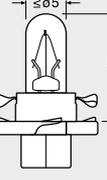
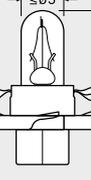
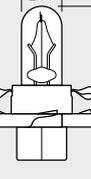
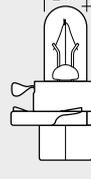
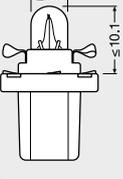
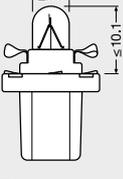
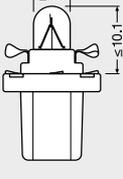
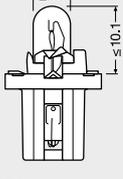
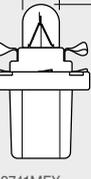
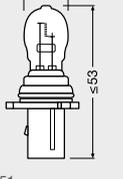
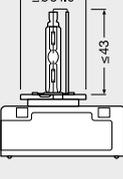
 PR21/5W	 PS19W	 PS24W	 PSX24W	 R5W, R10W, RY10W	 T4W, 3860
43	44	45	46	47	48
 W2.3W	 W3W, 2820	 W5W, WY5W, 2886X	 W16W	 WY16W	 W21W, WY21W
49	50	51	52	53	54
 W21/5W	 2341	 2721, 2722, 2741	 2840	 3796	 6411, 6413, 6421, 6424, 6429
55	56	57	58	59	60
 6428, 6430	 6438	 6461	 64111, 64113, 64115	 2351MFX6	 2352MFX6
61	62	63	64	65	66
 2452MFX6	 2473MFX6	 2721MF	 2721MFX	 2722MF	 2722MFX
67	68	69	70	71	72
 2741MF, 2741MFX	 828, 6851	 D5S			
73	74	75			

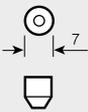
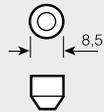
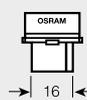
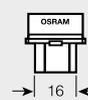
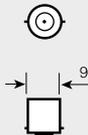
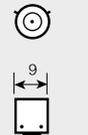
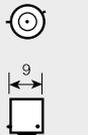
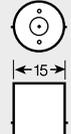
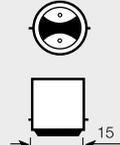
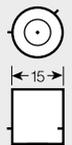
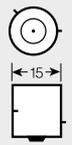
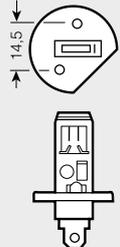
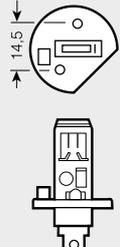
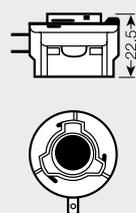
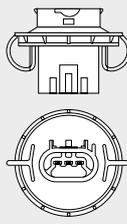
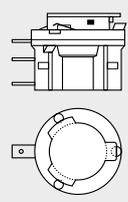
						
SV7-8 IEC 7004-80	SV8.5-8 IEC 7004-81	W2x4.6d IEC 7004-94	W2.1x9.5d IEC 7004-91	W2.5x16d IEC 7004-104	W2.5x16q IEC 7004-104	
Lampholder standard: IEC 7005-80	IEC 7005-80	IEC 7005-94	IEC 7005-91	IEC 7005-104	IEC 7005-104	
						
BA9s IEC 7004-14	BAY9s BAW9s IEC 7004-9	BAX9s IEC 7004-8	BX8.4d	B8.5d	BA15s IEC 7004-11A	BA15d IEC 7004-11A
Lampholder standard: IEC 7005-12	IEC 7005-9	IEC 7005-8	IEC 7005-140		IEC 7005-13	
						
BAU15s IEC 7004-19	BAW15s IEC 7004-11 E	BAY15d IEC 7004-11 B	BAZ15d IEC 7004-11 C	BAW15d IEC 7004-11 E	BA20d IEC 7004-12	
Lampholder standard: IEC 7005-13	IEC 7005-13	IEC 7005-13	IEC 7005-13	IEC 7005-13	IEC 7005-14	
						
P14.5s IEC 7004-46	PX14.5s	PX26d IEC 7004-5	PGJY19-2 PGJY19-5 PGJY19-1	P26.4t	PGJ23t-1	
Lampholder standard: IEC 7005-46		IEC 7005-5	IEC 7004-146 IEC 7005-146	IEC 7005-128	IEC 7004-155 IEC 7005-155	

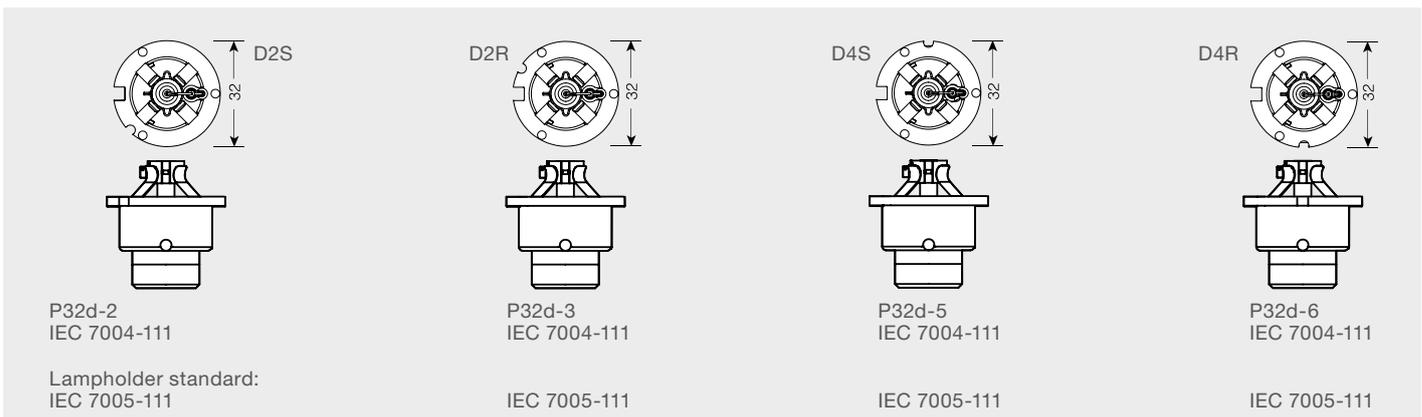
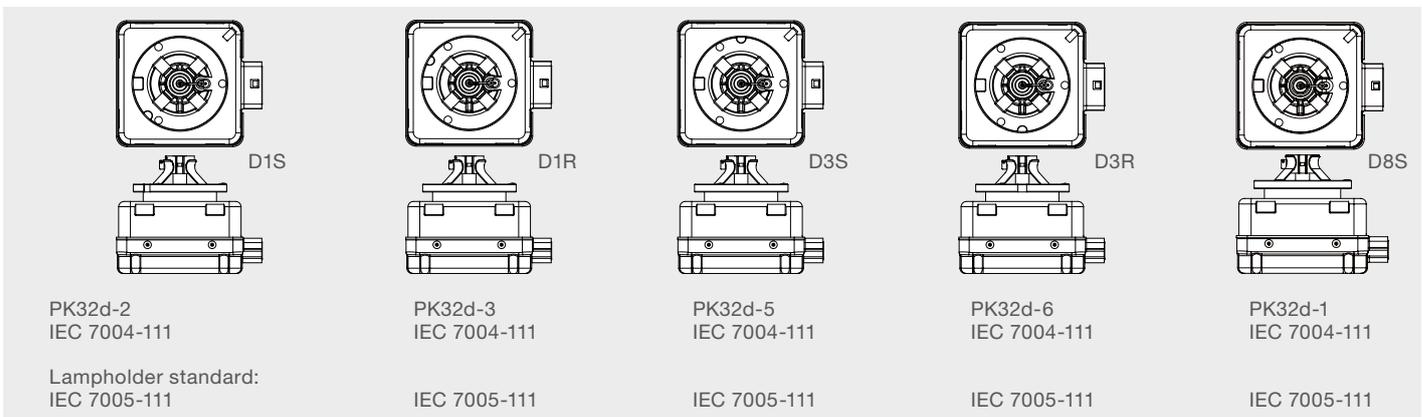
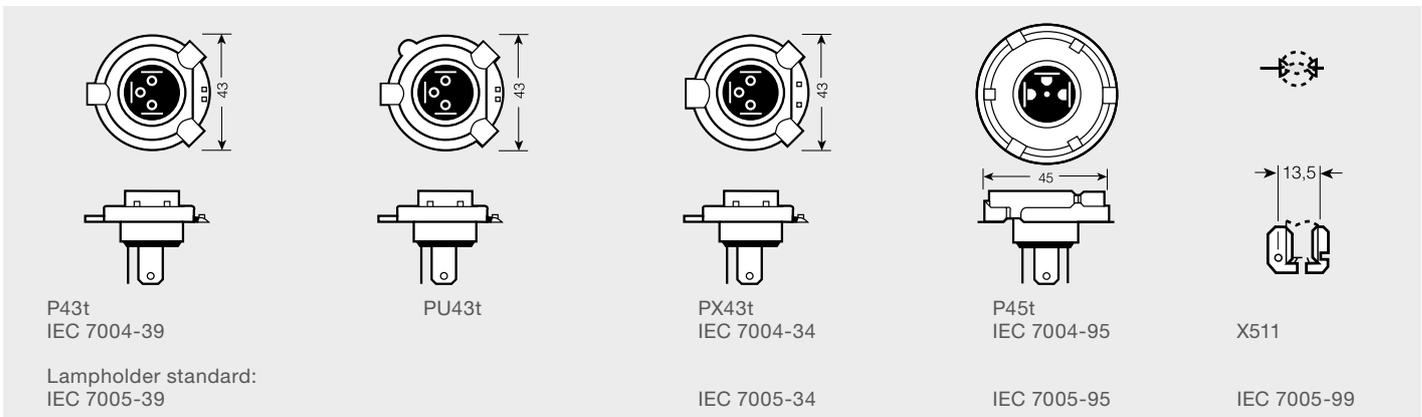
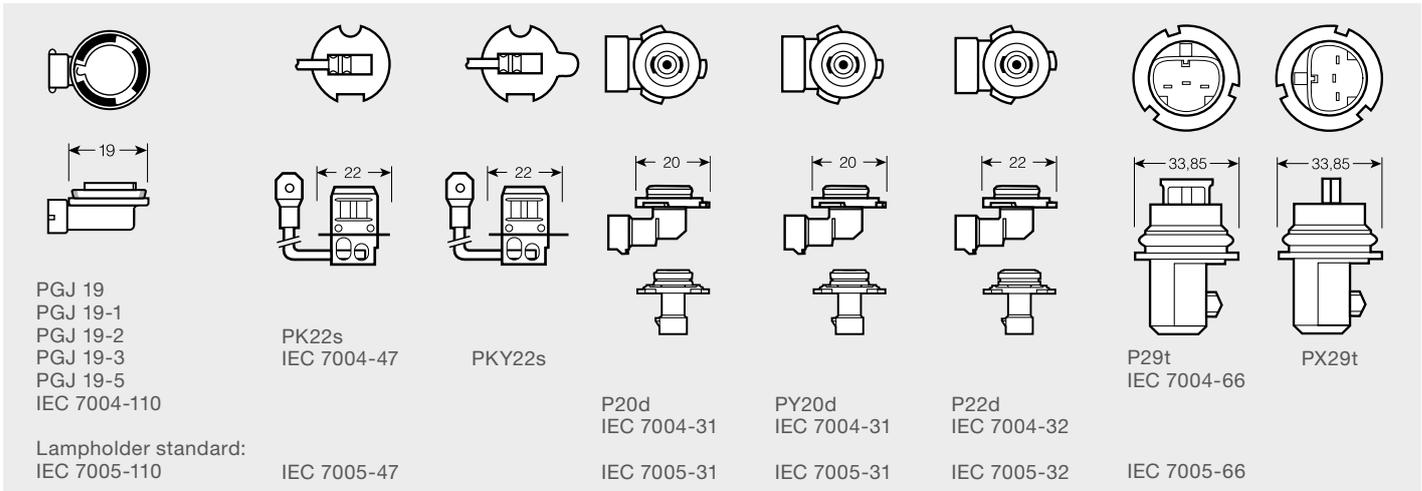

Type overview by ECE/SAE category

ECE	V	W		Product Reference		ECE	V	W		Product Reference	
-	12	-	-	LEDCAP01	P.11	-	12/24	55	-	LEDDL118-CB	P.45
-	12	-	-	LEDCAP02	P.11	-	12/24	22	-	LEDDL119-WD	P.45
-	12	-	-	LEDCAP03	P.11	-	12/24	108	-	LEDDL120-CB SM	P.45
-	12	-	-	LEDCAP04	P.11	-	12/24	20	-	LEDWL101-SP	P.46
-	12	-	-	LEDCAP06	P.11	-	12/24	8	-	LEDWL102-SP	P.46
-	12	-	-	LEDCAP07	P.11	-	12/24	8	-	LEDWL103-WD	P.46
-	12	5	-	LEDCBC101	P.16	-	12	2.4	-	LEDDMI 3G0 WT S	P.41
-	12	21	-	LEDCBCTRL102	P.16	-	12	2.4	-	LEDDMI 5F0 WT S	P.41
-	12	-	-	LEDDL ACC 101	P.45	-	12	2.4	-	LEDDMI 5F0 BK S	P.41
-	12	-	-	LEDDL ACC 102	P.45	-	12	2.4	-	LEDDMI 5G0 WT S	P.40
-	12	-	-	LEDDL ACC 103	P.45	-	12	2.4	-	LEDDMI 5G0 BK S	P.40
-	12/24	27	-	LEDPWL 101-UW	P.46	-	12	5.9	-	LEDDMI 5K0 WT S	P.40
-	12/24	33	-	LEDPWL 102-UW	P.46	-	12	5.9	-	LEDDMI 5K0 BK S	P.40
-	12/24	45	-	LEDPWL 103-UW	P.46	-	12	2.4	-	LEDDMI 8W0 WT S	P.42
-	12/24	27	-	LEDPWL 104-WD	P.46	-	12	2.4	-	LEDDMI 8W0 BK S	P.42
-	12/24	33	-	LEDPWL 105-WD	P.46	-	12	2.4	-	LEDDMI 8V0 WT S	P.42
-	12/24	45	-	LEDPWL 106-WD	P.46	-	12	2.4	-	LEDDMI 8V0 BK S	P.42
-	12/24	27	-	LEDPWL 107-FL	P.46	-	12	4.56	-	LEDDMI F20 WT S	P.41
-	12/24	33	-	LEDPWL 108-FL	P.46	-	12	4.56	-	LEDDMI F20 BK S	P.41
-	12/24	45	-	LEDPWL 109-FL	P.46	-	12	15	-	LEDDRL102	P.47
-	12/24	27	-	LEDPWL 110-SP	P.46	-	12	13.5	-	LEDDRL301 CL15	P.47
-	12/24	33	-	LEDPWL 111-SP	P.46	-	12	-	-	LEDEC01-2HFB	P.11
-	12/24	45	-	LEDPWL 112-SP	P.46	-	12	70	-	LEDHL102-BK	P.38
-	12/24	15	-	LEDPWL 113-UW	P.46	-	12	70	-	LEDHL102-BK RHD	P.38
-	12/24	15	-	LEDPWL 114-WD	P.46	-	12	70	-	LEDHL102-CM	P.38
-	12/24	15	-	LEDPWL 115-FL	P.46	-	12	70	-	LEDHL102-GTI	P.38
-	12/24	15	-	LEDPWL 116-SP	P.46	-	12	70	-	LEDHL103-GTI	P.35
-	12	-	-	LEDPWL ACC 101	P.45	-	12	70	-	LEDHL103-BK	P.35
-	12	-	-	LEDPWL ACC 102	P.45	-	12	70	-	LEDHL103-CM	P.35
-	12	-	-	LEDPWL ACC 103	P.45	-	12	70	-	LEDHL103-CM RHD	P.35
-	12	22/2	-	LEDDL101-SP	P.46	-	12	70	-	LEDHL104-GTI	P.36
-	12	22/2	-	LEDDL101-WD	P.46	-	12	70	-	LEDHL104-BK	P.36
-	12/24	30/2	-	LEDDL102-SP	P.45	-	12	70	-	LEDHL104-CM	P.36
-	12/24	30/2	-	LEDDL102-WD	P.46	-	12	70	-	LEDHL105	P.37
-	12/24	35	-	LEDDL103-SP	P.44	-	12	-	-	LEDHL107-BK	P.36
-	12/24	35	-	LEDDL103-CB	P.44	-	12	-	-	LEDHL107-BK RHD	P.36
-	12/24	36	-	LEDDL104-SP	P.44	-	12	-	-	LEDHL108-BK	P.37
-	12/24	68	-	LEDDL104-CB	P.44	-	12	-	-	LEDHL108-CM	P.37
-	12/24	68	-	LEDDL104-CB SM	P.44	-	12	-	-	LEDHL109-BK	P.36
-	12/24	14	-	LEDDL105-SP	P.45	-	12	-	-	LEDHL109-GTI	P.36
-	12/24	29	-	LEDDL106-SP	P.45	-	12/24	34	-	LEDUHL101	P.39
-	12/24	29	-	LEDDL106-CB	P.45	-	12/24	34	-	LEDUHL102	P.39
-	12/24	46	-	LEDDL107-SP	P.45	-	12/24	28	-	LEDUHL103	P.39
-	12/24	44	-	LEDDL107-CB	P.45	-	12/24	28	-	LEDUHL104	P.39
-	12/24	15	-	LEDDL108-WD	P.45	-	-	-	-	LEDUHL MOUNT101	P.39
-	12/24	15	-	LEDDL109-WD	P.45	-	12	-	-	LEDINT201 ¹⁾	P.48
-	12/24	45/1	-	LEDDL110-CB	P.45	-	12	-	-	LEDINT201-SEC ¹⁾	P.48
-	12/24	39/1	-	LEDDL111-CB	P.45	-	12	-	-	LEDINT202 ¹⁾	P.48
-	12/24	60/2.5	-	LEDDL112-CB	P.45	-	12	-	-	LEDINT203 ¹⁾	P.48
-	12/24	70/1.5	-	LEDDL113-CB	P.45	-	12	-	-	LEDSC01-2HFB	P.16
-	12/24	27	-	LEDDL115-SP	P.45	-	12	-	-	LEDSC01-2HFB	P.24
-	12/24	63	-	LEDDL116-SP	P.45	-	12	-	-	LEDSC02-1-2HFB	P.24
-	12/24	30	-	LEDDL117-CB	P.45	-	12	-	-	LEDSC03-2HFB	P.24

ECE	V	W		Product Reference	
-	12	-	-	LEDSC03-1-2HFB	P.24
-	12	30	-	LEDTL102-CL	P.43
-	12	27	-	LEDTL101-CL	P.43
-	12	1.6	PG18.5d-1	828DWP ¹⁾	P.14
-	12	2.1	W2.1x9.5d	921DWP ¹⁾	P.15
-	12	1.4	W2.1x9.5d	921DRP ¹⁾	P.15
-	12	1.2	BX8.4d	2351MFX6	P.27
-	12	2	BX8.4d	2352MFX6	P.27
-	12	1.5	BX8.4d	2452MFX6	P.27
-	12	1.12	BX8.4d	2473MFX6	P.27
-	12	6.7	PG20-7	2604CW	P.14
-	12	1.2	W2x4.6d	2721	P.26
-	12	1.2	B8.5d	2721MF	P.27
-	12	1.2	BX8.5d	2721MFX	P.27
-	12	2	W2x4.6d	2722	P.26
-	12	2	B8.5d	2722MF	P.27
-	12	2	BX8.5d	2722MFX	P.27
-	12	0.25	W2x4.6d	2723DWP ¹⁾	P.15
-	12	2	W2.1x9.5d	2820	P.26
-	12	0.8	W2.1x9.5d	2825DWP ¹⁾	P.14
-	12	0.6	W2.1x9.5d	2825DRP ¹⁾	P.14
-	12	1	W2.1x9.5d	2827DYP ¹⁾	P.14
-	12	6	W2.1x9.5d	2886X	P.26
-	12	27/7	W2.5x16q	3157A	P.27
-	12	2.0	W3x16q	3157DWP ¹⁾	P.15
-	12	1.4	W3x16q	3157DRP ¹⁾	P.15
-	12	1.3	W3x16q	3157DYP ¹⁾	P.15
-	12	2	BA9s	3796	P.27
-	12	5	BA9s	3860	P.26
-	12	0.8	BA9s	3893DWP ¹⁾	P.15
-	12	0.5	BA15s	5007DWP ¹⁾	P.15
-	12	1.2	BA15s	5008DWP ¹⁾	P.15
-	12	1.6	PG20-1	5201DWP ¹⁾	P.14
-	12	10	SV8.5-8	6411	P.27
-	12	5	SV8.5-8	6413	P.27
-	12	0.6	SV8.5-8	6413DWP ¹⁾	P.15
-	12	0.6	SV8.5-8	6418DWP ¹⁾	P.15
-	12	3	SV7-8	6428	P.27
-	12	10	SV8.5-8	6438	P.27
-	12	1.0	SV8.5-8	6438DWP ¹⁾	P.15
-	12	10	SV8.5-8	6461	P.27
-	12	6	SV8.5-8	6486X	P.27
-	12	21/5	BA15d	7240	P.26
-	12	5/5	P15d-25-1	7335DWP ¹⁾	P.15
-	12	1.3	WX3x16d	7504DYP ¹⁾	P.15
-	12	2.0	W3x16d	7505DWP ¹⁾	P.15
-	12	1.4	W3x16d	7505DRP ¹⁾	P.15
-	12	1.3	W3x16d	7505DYP ¹⁾	P.15
-	12	1.9	BA15s	7506DWP ¹⁾	P.15
-	12	1.9	BA15s	7506DRP ¹⁾	P.15
-	12	1.3	BA15s	7506DYP ¹⁾	P.15
-	12	1.3	BAU15s	7507DYP ¹⁾	P.15
-	12	1.9	W3x16q	7515DWP ¹⁾	P.15

ECE	V	W		Product Reference	
-	12	1.7	W3x16q	7515DRP ¹⁾	P.15
-	12	1.7	W3x16q	7515DYP ¹⁾	P.15
-	12	2.0	BA15d	7528DWP ¹⁾	P.15
-	12	1.4	BA15s	7528DRP ¹⁾	P.15
-	12	1.3	BA15s	7528DYP ¹⁾	P.15
(HB3/H10/HIR1)	12	19	P20d /PY20d/ PX20d	9005DWBRT ¹⁾	P.13
(HB4/HIR2)	12	19	P22d/PX22d	9006DWBRT ¹⁾	P.13
(H13)	12	15/10	P26.4t	9008DWBRT ¹⁾	P.13
-	12	13	PY20d	9745CW	P.14
-	12	80	P14.5s	62150CBB ¹⁾	P.34
-	12	100/90	P43t	62193CBB ¹⁾	P.34
-	12	100	P14.5s	62200SBP ¹⁾	P.33
-	12	100	PK22s	62201SBP ¹⁾	P.33
-	12	100/90	P43t	62204SBP ¹⁾	P.33
-	12	80	PX26d	62210CBB ¹⁾	P.34
-	12	75	PGJ19-2	62211CBB ¹⁾	P.34
-	12	80	PX26d	62261SBP ¹⁾	P.33
-	12	20	BA9s	64111	P.27
-	12	10	BA9s	64113	P.27
-	12	5	BA9s	64115	P.27
(H1)	12	13	P14.5s	64150DWBRT ¹⁾	P.13
(H15)	12	3.8/16.5	PGJ23t-1	64176DWESY	P.12
-	12	100	PX14.5s	64152SB ¹⁾	P.33
-	12	100	PKX22s	64153SB ¹⁾	P.33
-	12	5/5	PX43t	64185DWP ¹⁾	P.15
(H4/H19)	12	15/15	P43t/PU43t-3	64193DWBRT ¹⁾	P.13
(H4/H19)	12	18.7/19	P43t/PU43t-3	64193DWESY ¹⁾	P.12
(H4/H19)	12	27/23	P43t/PU43t-3	64193DWINT ¹⁾	P.13
(H4)	12	23/27	P43t	64193DWNB	P.22
-	12	60/55	P45t	64198SB ¹⁾	P.33
-	-	-	-	64210DA01	P.17
-	-	-	-	64210DA01-1	P.17
-	-	-	-	64210DA02	P.17
-	-	-	-	64210DA03	P.17
-	-	-	-	64210DA03-1	P.17
-	-	-	-	64210DA04	P.17
-	-	-	-	64210DA05	P.17
-	-	-	-	64210DA06	P.17
-	-	-	-	64210DA06-1	P.17
-	-	-	-	64210DA07	P.17
-	-	-	-	64210DA08	P.17
(H7/H18)	12	19	PX26d/PY26d-1	64210DWBRT ¹⁾	P.13
(H7/H18)	12	16	PX26d/PY26d-1	64210DWESY ¹⁾	P.12
(H7/H18)	12	16	PX26d/PY26d-1	64210DWINT ¹⁾	P.13
(H7)	12	19	PX26d	64210DWNB	P.22
(H8/H11/H16/H9)	12	19	PGJ19-X	64211DWBRT ¹⁾	P.13
-	12/24	35	PK32d-2	66140CBB ¹⁾	P.34
-	12/24	35	P32d-2	66240CBB ¹⁾	P.34
-	12/24	35	PK32d-5	66340CBB ¹⁾	P.34
-	12/24	35	P32d-5	66440CBB ¹⁾	P.34

ECE	V	W		Product Reference	
-	12	13	PGJ19	67219CW	P.14
-	12	100	P20d	69005SBP ¹⁾	P.33
-	12	80	P22d	69006SBP ¹⁾	P.33
-	24	1	W2x4.6d	2341	P.30
-	24	1.2	W2x4.6d	2741	P.30
-	24	1.2	B8.5d	2741MF	P.30
-	24	1.2	BX8.5d	2741MFX	P.30
-	24	2	W2.1x9.5d	2840	P.30
-	24	2	BA9s	3797	P.30
-	24	3	SV8.5-8	6421	P.30
-	24	3	SV8.5-8	6430	P.30
-	24	5	SV8.5-8	6424	P.30
-	24	10	SV8.5-8	6429	P.30
-	24	15	BA15s	7529	P.30
-	24	12	P14.5s	64155DWS ¹⁾	P.16
-	24	13/13	P43t	64196DWS ¹⁾	P.16
-	24	18	PX26d	64215DWS ¹⁾	P.16
C5W	12	5	SV8.5-8	6418	P.27
C5W	12	5	SV8.5-8	6418ULT	P.25
C5W	24	5	SV8.5-8	6423	P.30
D1S	85	35	PK32d-2	66140	P.20
D1S	85	35	PK32d-2	66140XNN	P.18
D1S	85	35	PK32d-2	66140CBN	P.19
D1S	85	35	PK32d-2	66140ULT	P.19
D1R	85	35	PK32d-3	66150	P.20
D1R	85	35	PK32d-3	66150CBN	P.19
D2S	85	35	P32d-2	66240	P.20
D2S	85	35	P32d-2	66240XNN	P.18
D2S	85	35	P32d-2	66240CBN	P.19
D2S	85	35	P32d-2	66240ULT	P.19
D2R	85	35	P32d-3	66250	P.20
D2R	85	35	P32d-3	66250CBN	P.19
D3S	42	35	PK32d-5	66340	P.20
D3S	42	35	PK32d-5	66340XNN	P.18
D3S	42	35	PK32d-5	66340CBN	P.19
D3S	42	35	PK32d-5	66340ULT	P.19
D3R	42	35	PK32d-6	66350	P.20
D4S	42	35	P32d-5	66440	P.20
D4S	42	35	P32d-5	66440XNN	P.18
D4S	42	35	P32d-5	66440CBN	P.19
D4S	42	35	P32d-5	66440ULT	P.19
D4R	42	35	P32d-6	66450	P.20
D5S	12	25	PK32d-7	66540	P.20
D8S	42	25	PK32d-1	66548	P.20
D8S	42	25	PK32d-1	66548CBN	P.19
H1	12	55	P14.5s	64150	P.25
H1	12	55	P14.5s	64150NL	P.22
H1	12	55	P14.5s	64150NBS	P.22
H1	12	55	P14.5s	64150CBN	P.23
H1	12	55	P14.5s	64150ULT	P.24
H1	24	70	P14.5s	64155	P.30
H1	24	70	P14.5s	64155TSP	P.29
H10	12	42	PY20d	9145	P.25

ECE	V	W		Product Reference	
H11	12	55	PGJ19-2	64211	P.25
H11	12	55	PGJ19-2	64211NB200	P.21
H11	12	55	PGJ19-2	64211NL	P.22
H11	12	55	PGJ19-2	64211NBS	P.23
H11	12	55	PGJ19-2	64211CBN	P.23
H11	12	55	PGJ19-2	64211ULT	P.24
H11	24	70	PGJ19-2	64216TSP	P.29
H11B	12	55	PGJY19-2	64241	P.25
H13	12	60/55	P26.4t	9008	P.25
H15	12	55/15	PGJ23t-1	64176	P.26
H15	12	55/15	PGJ23t-1	64176CBN	P.23
H15	24	20/60	PGJ23t-1	64177	P.30
H16	12	19	PGJ19-3	64219L+	P.26
H18	12	55	PY26d-1	64180L	P.26
H19	12	60/55	PU43t-3	64181L	P.26
H21W	12	21	BAY9s	64136	P.26
H21W	24	21	BAY9s	64138	P.30
H27W/1	12	27	PG13	880	P.26
H27W/2	12	27	PGJ13	881	P.26
H3	12	55	PK22s	64151	P.25
H3	12	55	PK22s	64151NL	P.22
H3	24	70	PK22s	64156	P.30
H3	24	70	PK22s	64156TSP	P.29
H4	12	60/55	P43t	64193	P.25
H4	12	60/55	P43t	64193NB200	P.21
H4	12	60/55	P43t	64193NL	P.22
H4	12	60/55	P43t	64193NBS	P.23
H4	12	60/55	P43t	64193CBN	P.23
H4	12	60/55	P43t	64193ULT	P.24
H4	24	75/70	P43t	64196	P.30
H4	24	75/70	P43t	64196TSP	P.29
H4	24	75/70	P43t	94196	P.30
H6W	12	6	BAX9s	64132	P.26
H6W	12	6	BAX9s	64132ULT	P.25
H7	12	55	PX26d	64210	P.25
H7	12	55	PX26d	64210NB200	P.21
H7	12	55	PX26d	64210NL	P.22
H7	12	55	PX26d	64210NBS	P.23
H7	12	55	PX26d	64210CBN	P.23
H7	12	55	PX26d	64210ULT	P.24
H7	24	70	PX26d	64215	P.30
H7	24	70	PX26d	64215TSP	P.29
H8	12	35	PGJ19-1	64212	P.25
H8	12	35	PGJ19-1	64212NL	P.22
H8	12	35	PGJ19-1	64212CBN	P.23
H8B	12	35	PGJY19-1	64242	P.25
H9	12	65	PGJ19-5	64213	P.25
H9B	12	65	PGJY19-5	64243	P.25
HB3	12	60	P20d	9005	P.26
HB3	12	60	P20d	9005NL	P.22
HB3	12	60	P20d	9005CBN	P.23
HB3A	12	60	P20d	9005XS	P.26
HB4	12	51	P22d	9006	P.26

ECE	V	W		Product Reference		ECE	V	W		Product Reference	
HB4	12	51	P22d	9006NL	P.22	R10W	12	10	BA15s	5008	P.26
HB4	12	51	P22d	9006CBN	P.23	R10W	12	10	BA15s	5008ULT	P.25
HB4A	12	51	P20d	9006XS	P.26	R10W	24	10	BA15s	5637	P.30
HB5	12	65/55	PX29t	9007	P.26	R10W	24	10	BA15s	5637TSP	P.30
HIR1	12	65	PX20d	9011	P.26	R5W	12	5	BA15s	5007	P.26
HIR2	12	55	PX22d	9012	P.26	R5W	12	5	BA15s	5007ULT	P.25
HIR2	12	55	PX22d	9012CBN	P.23	R5W	24	5	BA15d	5626	P.30
HS1	12	35/35	PX43t	64185	P.32	R5W	24	5	BA15s	5627	P.30
HY21W	12	21	BAW9s	64137ULT	P.25	R5W	24	5	BA15s	5627TSP	P.30
P13W	12	13	PG18,5d-1	828	P.27	RY10W	12	10	BAU15s	5009	P.26
P21W	12	21	BA15s	7506	P.26	S1	12	25/25	BA20d	64326	P.32
P21W	12	21	BA15s	7506ULT	P.24	S2	12	35/35	BA20d	64327	P.32
P21W	24	21	BA15s	7511	P.30	T4W	12	4	BA9s	3893	P.26
P21W	24	21	BA15s	7511TSP	P.29	T4W	24	4	BA9s	3930	P.30
P21/4W	12	21/4	BAZ15d	7225	P.26	T4W	24	4	BA9s	3930TSP	P.30
P21/5W	12	21/5	BAY15d	7528	P.26	W16W	12	16	W2.1x9.5d	921	P.26
P21/5W	12	21/5	BAY15d	7528ULT	P.24	W2.3W	12	2.3	W2x4.6d	2723	P.26
P21/5W	24	21/5	BAY15d	7537	P.30	W21/5W	12	21/5	W3x16q	7515	P.26
P21/5W	24	21/5	BAY15d	7537TSP	P.30	W21W	12	21	W3x16d	7505	P.26
P27W	12	27	W2.5x16d	3156	P.27	W3W	12	3	W2.1x9.5d	2821	P.26
P27/7W	12	27/7	W2.5x16q	3157	P.27	W3W	24	3	W2.1x9.5d	2841	P.30
PS19W	12	19	PG20-1	5201	P.27	W5W	12	5	W2.1x9.5d	2825	P.26
PS24W	12	24	PG20-3	5202	P.27	W5W	12	5	W2.1x9.5d	2825ULT	P.24
PSX24W	12	24	PG20-7	2504	P.27	W5W	12	5	W2.1x9.5d	2825CBN	P.23
PSX26W	12	26	PG18.5d-3	6851	P.27	W5W	24	5	W2.1x9.5d	2845	P.30
PY21W	12	21	BAU15s	7507	P.26	W5W	24	5	W2.1x9.5d	2845TSP	P.30
PY21W	12	21	BAU15s	7507ULT	P.24	WY5W	12	5	W2.1x9.5d	2827NA	P.26
PY21W	12	21	BAU15s	7507DC	P.24	WY16W	12	16	W2.1x9.5d	921NA	P.26
PY21W	24	21	BAU15s	7510TSP	P.29	WY5W	12	5	W2.1x9.5d	2827DC	P.24
PY27/7W	12	27/7	WX2.5x16q	3757AK	P.27	WY21W	12	21	WX3x16d	7504	P.26

1) These products do not have ECE approval and must not be used on public roads in any exterior application. Public roads use leads to cancellation of operating license and loss of insurance coverage. Several countries forbid sale and use of these products. Please contact your local distributor for further information.

Type overview in numerical order of product reference with test data

Product Reference	ECE	V	W		V _{Test}	W _{In}	lm	T _h E5/TC 1)	
828	P13W	12	13	PG18,5d-1	13.5	19	250	1000	P.27
828DWP ²⁾	-	12	1.6	PG18.5d-1	13.5	1.9	130	1500/4000	P.14
880	H27W/1	12	27	PG13	13.5	31	450	-	P.26
881	H27W/2	12	27	PGJ13	13.5	31	450	-	P.26
921	W16W	12	16	W2.1x9.5d	13.5	19.4	310	400/1000	P.26
921DWP ²⁾	-	12	2.1	W2.1x9.5d	13.5	2.9	280	1500/4000	P.15
921DRP ²⁾	-	12	1.4	W2.1x9.5d	13.5	2.00	80	1500/4000	P.15
921NA	WY16W	12	16	W2.1x9.5d	13.5	19.4	190	400/1000	P.26
2341	-	24	1	W2x4.6d	28.0	1	3	300/1000	P.30
2351MFX6	-	12	1.2	BX8.4d	13.5	1.32	7.5	600/3000	P.27
2352MFX6	-	12	2	BX8.4d	13.5	2.13	11.8	1500/6000	P.27
2452MFX6	-	12	1.5	BX8.4d	13.5	1.8	6.5	1700/6500	P.27
2473MFX6	-	12	1.12	BX8.4d	14.0	1.12	3.6	500/5000	P.27
2504	PSX24W	12	24	PG20-7	13.5	max. 25	500	500/1000	P.27
2604CW	-	12	6.7	PG20-7	13.2	6.7	730	2500/5000	P.14
2721	-	12	1.2	W2x4.6d	13.5	1.22	7.5	500/2000	P.26
2721MF	-	12	1.2	B8.5d	13.5	1.2	6.4	500/2000	P.27
2721MFX	-	12	1.2	BX8.5d	13.5	1.2	6.4	500/2000	P.27
2722	-	12	2	W2x4.6d	13.5	2	12	1300/4000	P.26
2722MF	-	12	2	B8.5d	13.5	2	10.2	1300/4000	P.27
2722MFX	-	12	2	BX8.5d	13.5	2	10.2	1300/4000	P.27
2723	W2.3W	12	2.3	W2x4.6d	13.5	2.5	18.6	350/1200	P.26
2723DWP ²⁾	-	12	0.25	W2x4.6d	-	-	-	-	P.15
2741	-	24	1.2	W2x4.6d	28.0	1.6	7.5	400/2000	P.30
2741MF	-	24	1.2	B8.5d	28.0	1.6	6.4	400/2000	P.30
2741MFX	-	24	1.2	BX8.5d	28.0	1.6	6.4	400/2000	P.30
2820	-	12	2	W2.1x9.5d	13.5	2.2	13.5	600/4000	P.26
2821	W3W	12	3	W2.1x9.5d	13.5	3	22	1300/4000	P.26
2825	W5W	12	5	W2.1x9.5d	13.5	5	50	350/1000	P.26
2825DWP ²⁾	-	12	0.8	W2.1x9.5d	13.5	1.12	70	1500/4000	P.14
2825DRP ²⁾	-	12	0.6	W2.1x9.5d	13.5	0.8	15	1500/4000	P.14
2825CBN	W5W	12	5	W2.1x9.5d	13.5	5	50	350/1000	P.23
2825ULT	W5W	12	5	W2.1x9.5d	13.5	5	50	700/1500	P.24
2827DC	WY5W	12	5	W2.1x9.5d	13.5	5	30	200/500	P.24
2827DYP ²⁾	-	12	1	W2.1x9.5d	13.5	0.7	7	1500/4000	P.14
2827NA	WY5W	12	5	W2.1x9.5d	13.5	5	30	350/1000	P.26
2840	-	24	2	W2.1x9.5d	28.0	2.6	13	500/5000	P.30
2841	W3W	24	3	W2.1x9.5d	28.0	4	22	500/5000	P.30
2845	W5W	24	5	W2.1x9.5d	28.0	7	50	800/3000	P.30
2845TSP	W5W	24	5	W2.1x9.5d	28.0	7	50	1000/4000	P.30
2886X	-	12	6	W2.1x9.5d	13.5	6	85	400/1000	P.26
3156	P27W	12	27	W2.5x16d	13.5	29.2	475	600/0	P.27
3157	P27/7W	12	27/7	W2.5x16q	13.5	29.2/7.7	475/36	600/5000	P.27
3157A	-	12	27/7	W2.5x16q	-	-	-	-	P.27
3157DWP ²⁾	-	12	2.0	W3x16q	13.5	2.5/0.6	145/30	1500/4000	P.15
3157DRP ²⁾	-	12	1.4	W3x16q	13.5	1.8/0.6	60/10	1500/4000	P.15
3157DYP ²⁾	-	12	1.3	W3x16q	13.5	1.7/1.1	55/10	1500/4000	P.15
3757AK	PY27/7W	12	27/7	WX2.5x16q	13.5	29.2/17.7	280/21	460/1100	P.27
3796	-	12	2	BA9s	13.5	2	12.5	300/750	P.27
3797	-	24	2	BA9s	28	3	17.5	1000/2000	P.30

Product Reference	ECE	V	W		V _{Test}	W _{In}	lm	T[h] E5/7c 1)	
3860	-	12	5	BA9s	13.5	5	50	400/1000	P.26
3893	T4W	12	4	BA9s	13.5	4	35	600/1200	P.26
3893DWP ²⁾	-	12	0.8	BA9s	13.5	1.0	75	1500/4000	P.15
3930	T4W	24	4	BA9s	28.0	5	35	250/500	P.30
3930TSP	T4W	24	4	BA9s	28.0	5	35	550/1000	P.30
5007	R5W	12	5	BA15s	13.5	5	50	350/800	P.26
5007DWP ²⁾	-	12	0.5	BA15s	-	-	-	-	P.15
5007ULT	R5W	12	5	BA15s	13.5	5	50	600/1200	P.25
5008	R10W	12	10	BA15s	13.5	10	125	350/800	P.26
5008DWP ²⁾	-	12	1.2	BA15s	-	-	-	-	P.15
5008ULT	R10W	12	10	BA15s	13.5	10	125	600/1200	P.25
5009	RY10W	12	10	BAU15s	13.5	10	75	350/800	P.26
5201	PS19W	12	19	PG20-1	13.5	max. 20	350	500/1000	P.27
5201DWP ²⁾	-	12	1.6	PG20-1	13.5	1.9	140	1500/4000	P.14
5202	PS24W	12	24	PG20-3	13.5	max. 25	500	500/1000	P.27
5626	R5W	24	5	BA15d	28.0	7	50	80/250	P.30
5627	R5W	24	5	BA15s	28.0	7	50	500/1000	P.30
5627TSP	R5W	24	5	BA15s	28.0	7	50	800/2000	P.30
5637	R10W	24	10	BA15s	28.0	12.5	125	400/800	P.30
5637TSP	R10W	24	10	BA15s	28.0	12.5	125	1000/2000	P.30
6411	-	12	10	SV8.5-8	13.5	10	100	500/1000	P.27
6413	-	12	5	SV8.5-8	13.5	5	45	1000/2000	P.27
6413DWP ²⁾	-	12	0.6	SV8.5-8	13.5	0.8	55	2500/5000	P.15
6418	C5W	12	5	SV8.5-8	13.5	5	45	1000/2000	P.27
6418DWP ²⁾	-	12	0.6	SV8.5-8	13.5	0.8	45	2500/5000	P.15
6418ULT	C5W	12	5	SV8.5-8	13.5	5	45	1500/4000	P.25
6421	-	24	3	SV8.5-8	24.0	3	17	800/1500	P.30
6423	C5W	24	5	SV8.5-8	28.0	7	45	1500/4000	P.30
6424	-	24	5	SV8.5-8	28.0	7	60	1000/2000	P.30
6428	-	12	3	SV7-8	13.5	3.5	29	600/1200	P.27
6429	-	24	10	SV8.5-8	28.0	10	105	300/600	P.30
6430	-	24	3	SV7-8	28.0	3	23	400/800	P.30
6438	-	12	10	SV8.5-8	13.0	10	120	200/500	P.27
6438DWP ²⁾	-	12	1	SV8.5-8	13.5	45	1.2	2500/5000	P.15
6461	-	12	10	SV8.5-8	13.5	10	105	600/1200	P.27
6486X	-	12	6	SV8.5-8	13.5	6	85	350/600	P.27
6851	PSX26W	12	26	PG18.5d-3	13.5	26	500	1000	P.27
7225	P21/4W	12	21/4	BAZ15d	13.5	25/5	440/15	180/1250 //290/4000	P.26
7240	-	12	21/5	BA15d	13.5	25/6	440/35	180/1250//290/4000	P.26
7335DWP ²⁾	-	12	5/5	P15d-25-1	-	-	-	-	P.15
7504	WY21W	12	21	WX3x16d	13.5	25	280	400/600	P.26
7504DYP ²⁾	-	12	1.3	WX3x16d	13.5	1.8	55	1500/4000	P.30
7505	W21W	12	21	W3x16d	13.5	25	460	400/600	P.26
7505DWP ²⁾	-	12	2	W3x16d	13.5	2.8	145	1500/4000	P.15
7505DRP ²⁾	-	12	1.4	W3x16d	13.5	2.0	60	1500/4000	P.15
7505DYP ²⁾	-	12	1.3	W3x16d	13.5	2.0	55	1500/4000	P.15
7506	P21W	12	21	BA15s	13.5	25	460	250/500	P.26
7506DWP ²⁾	-	12	1.9	BA15s	13.5	2.5	160	1500/4000	P.15
7506DYP ²⁾	-	12	1.3	BA15s	13.5	2.8	100	1500/4000	P.15
7506DRP ²⁾	-	12	1.3	BA15s	13.5	2.8	50	1500/4000	P.15

Product Reference	ECE	V	W		V _{Test}	W _{In}	lm	T[h] E5/7c	1)
7506ULT	P21W	12	21	BA15s	13.5	25	460	500/1000	P.24
7507	PY21W	12	21	BAU15s	13.5	25	280	250/500	P.26
7507DC	PY21W	12	21	BAU15s	13.5	25	280	100/250	P.24
7507DYP ²⁾	-	12	1.3	BAU15s	13.5	1.8	50	1500/4000	P.15
7507ULT	PY21W	12	21	BAU15s	13.5	25	280	500/1000	P.24
7510TSP	PY21W	24	21	BAU15s	28.0	28	250	250/500	P.29
7511	P21W	24	21	BA15s	28.0	28	460	200/400	P.30
7511TSP	P21W	24	21	BA15s	28.0	28	460	250/500	P.29
7515	W21/5W	12	21/5	W3x16q	13.5	25/6	440/35	400/600//3000/3000	P.26
7515DWP ²⁾	-	12	1.9	W3x16q	13.5	2.7/0.6	155/25	1500/4000	P.15
7515DRP ²⁾	-	12	1.7	W3x16q	13.5	2.4/0.6	80/10	1500/4000	P.15
7515DYP ²⁾	-	12	1.7	W3x16q	13.5	1.8/1.3	50/10	1500/4000	P.15
7528	P21/5W	12	21/5	BAY15d	13.5	25/6	440/35	180/1250//290/4000	P.26
7528DWP ²⁾	-	12	2	BAY15d	13.5	2.5/0.5	145/30	1500/4000	P.15
7528DRP ²⁾	-	12	1.4	BAY15d	13.5	1.6/0.6	100/10	1500/4000	P.15
7528DYP ²⁾	-	12	1.3	BAY15d	13.5	1.5/0.9	55/10	1500/4000	P.15
7528ULT	P21/5W	12	21/5	BAY15d	13.5	25/6	440/35	300/3000//800/6000	P.24
7529	-	24	15	BA15s	28.0	15	210	100/300	P.30
7537	P21/5W	24	21/5	BAY15d	28.0	28/10	440/40	60/600//160/1600	P.30
7537TSP	P21/5W	24	21/5	BAY15d	28.0	28/10	440/40	100/1000//200/2000	P.30
9005	HB3	12	60	P20d	13.2	73	1860	280/550	P.26
9005DWBRT ²⁾	(HB3/H10/HIR1)	12	19	P20d/PY20d/PX20d	-	-	-	-	P.13
9005CBN	HB3	12	60	P20d	13.2	73	1860	110/220	P.23
9005NL	HB3	12	60	P20d	13.2	73	1860	110/210	P.22
9005XS	HB3A	12	60	P20d	13.2	max. 73	1860	-	P.26
9006	HB4	12	51	P22d	13.2	62	1095	860/1720	P.26
9006DWBRT ²⁾	(HB4/HIR2)	12	19	P22d/PX22d	-	-	-	-	P.13
9006CBN	HB4	12	51	P22d	13.2	62	1095	260/520	P.23
9006NL	HB4	12	51	P22d	13.2	62	1095	270/500	P.22
9006XS	HB4A	12	51	P20d	13.2	62	1095	860/1720	P.26
9007	HB5	12	65/55	PX29t	12.8	70/60	1350/1000	250/500	P.26
9008	H13	12	60/55	P26.4t	13.2	75/68	1700/1100	170/1290//350/2590	P.25
9008DWBRT ²⁾	(H13)	12	15/10	P26.4t	-	-	-	-	P.13
9011	HIR1	12	65	PX20d	13.2	max. 73	2500	220/300	P.62
9012	HIR2	12	55	PX22d	13.2	max. 63	1875	500/870	P.26
9012CBN	HIR2	12	55	PX22d	13.2	63	1875	300/500	P.23
9145	H10	12	42	PY20d	13.2	50	850	860/1720	P.25
9745CW ²⁾	-	12	13	PY20d	-	-	730	-	P.14
62150CBB ²⁾	-	12	80	P14.5s	13.2	80	1150	75/150	P.34
62193CBB ²⁾	-	12	100/90	P43t	13.2	100/90	1600/760	60/200//120/400	P.34
62200SBP ²⁾	-	12	100	P14.5s	13.2	max. 94	2600	23/50	P.33
62201SBP ²⁾	-	12	100	PK22s	13.2	max. 95	2300	22/50	P.33
62204SBP ²⁾	-	12	100/90	P43t	13.2	100/90	2900/1530	100/200//300/550	P.33
62210CBB ²⁾	-	12	80	PX26d	13.2	80	1100	150/350	P.34
62211CBB ²⁾	-	12	75	PGJ19-2	13.2	75	1000	200/400	P.34
62261SBP ²⁾	-	12	80	PX26d	13.2	80	1950	250/500	P.33
64111	-	12	5	BA9s	13.5	5	80	150/500	P.27
64113	-	12	10	BA9s	13.5	10	200	150/400	P.27
64115	-	12	20	BA9s	13.5	22.5	450	150/500	P.27
64132	H6W	12	6	BAX9s	13.5	7	125	350/700	P.26

Product Reference	ECE	V	W		V _{Test}	W _{in}	lm	T _h E5/7c 1)	
64132ULT	H6W	12	6	BAX9s	13.5	7	125	600/1000	P.25
64136	H21W	12	21	BAY9s	13.5	25	600	300/600	P.26
64137ULT	HY21W	12	21	BAW9s	13.5	26.25	300	400/700	P.25
64138	H21W	24	21	BAY9s	28.0	28	600	150/400	P.30
64150	H1	12	55	P14.5s	13.2	68	1550	400/650	P.25
64150DWBRT ²⁾	(H1)	12	13	P14.5s	-	-	-	-	P.13
64150NL	H1	12	55	P14.5s	13.2	68	1550	150/300	P.22
64150NBS	H1	12	55	P14.5s	13.2	68	1550	250/450	P.22
64150CBN	H1	12	55	P14.5s	13.2	68	1550	150/250	P.23
64150ULT	H1	12	55	P14.5s	13.2	68	1550	1200/2000	P.24
64151	H3	12	55	PK22s	13.2	68	1450	400/650	P.25
64151NL	H3	12	55	PK22s	13.2	68	1450	150/300	P.22
64152SB ²⁾	-	12	100	PX14,5s	13.2	93	2600	22.5/50	P.33
64153SB ²⁾	-	12	100	PKX22s	13.2	85	2300	23/50	P.33
64155	H1	24	70	P14.5s	28.0	84	1900	400/650	P.30
64155DWS ²⁾	(H1)	24	12	P14.5s	-	-	-	-	P.16
64155TSP	H1	24	70	P14.5s	28.0	84	1900	600/1200	P.29
64156	H3	24	70	PK22s	28.0	84	1750	400/650	P.30
64156TSP	H3	24	70	PK22s	28.0	max. 84	1750	600/1200	P.29
64176	H15	12	55/15	PGJ23t-1	13.2	19/64	260/1350	2000/250//4000/500	P.26
64176CBN	H15	12	55/15	PGJ23t-1	13.2	max. 19/64	260/1350	1000/100//2000/200	P.23
64176DWESY ²⁾	(H15)	12	3.8/16.5	PGJ23t-1	-	-	-	-	P.12
64177	H15	24	20/60	PGJ23t-1	28.0	max. 84	300/1500	1500/200//3000/400	P.30
64180L	H18	12	55	PY26d-1	13.2	max. 69	1700	700/1100	P.26
64181L	H19	12	60/55	PU43t-3	13.2	max. 68/72	1750/1200	300/600//800/1600	P.26
64185	HS1	12	35/35	PX43t	13.2	36.8/36.8	820/520	75/150//150/300	P.32
64185DWP ²⁾	(HS1)	12	5/5	PX43t	-	-	-	-	P.15
64193	H4	12	60/55	P43t	13.2	75/68	1650/1000	250/400//500/900	P.25
64193DWNB ²⁾	(H4)	12	23/27	P43t	-	-	-	-	P.22
64193DWBRT ²⁾	(H4/H19)	12	15/15	P43t/PU43t-3	-	-	-	-	P.13
64193DWESY ²⁾	(H4/H19)	12	18.7/19	P43t/PU43t-3	-	-	-	-	P.12
64193DWINT ²⁾	(H4/H19)	12	27/23	P43t/PU43t-3	-	-	-	-	P.13
64193NB200	H4	12	60/55	P43t	13.2	75/68	1650/1000	-	P.21
64193NL	H4	12	60/55	P43t	13.2	75/68	1650/1000	80/200//160/400	P.22
64193NBS	H4	12	60/55	P43t	13.2	75/68	1650/1000	250/400//450/700	P.23
64193CBN	H4	12	60/55	P43t	13.2	75/68	1650/1000	50/200//100/400	P.23
64193ULT	H4	12	60/55	P43t	13.2	75/68	1650/1000	300/2000//700/3000	P.24
64196	H4	24	75/70	P43t	28.0	85/80	1900/1200	170/350//400/800	P.30
64196DWS ²⁾	(H4)	24	13/13	P43t	-	-	-	-	P.16
64196TSP	H4	24	75/70	P43t	28.0	85/80	1900/1200	140/450//300/1000	P.29
64198SB ²⁾	-	12	60/55	P45t	13.2	75/68	1650/1000	250/400//500/900	P.33
64210DA01	-	-	-	-	-	-	-	-	P.17
64210DA01-1	-	-	-	-	-	-	-	-	P.17
64210DA02	-	-	-	-	-	-	-	-	P.17
64210DA03	-	-	-	-	-	-	-	-	P.17
64210DA03-1	-	-	-	-	-	-	-	-	P.17
64210DA04	-	-	-	-	-	-	-	-	P.17
64210DA05	-	-	-	-	-	-	-	-	P.17
64210DA06	-	-	-	-	-	-	-	-	P.17
64210DA07	-	-	-	-	-	-	-	-	P.17

Product Reference	ECE	V	W		V _{Test}	W _{in}	lm	T _h E5/TC 1)	
64210DA08	-	-	-	-	-	-	-	-	P.17
64210	H7	12	55	PX26d	13.2	58	1500	330/550	P.25
64210DWNB	(H7)	12	19	PX26d	-	-	-	-	P.22
64210NB200	H7	12	55	PX26d	13.2	58	1500	-	P.21
64210NL	H7	12	55	PX26d	13.2	58	1500	150/250	P.22
64210NBS	H7	12	55	PX26d	13.2	58	1500	250/450	P.23
64210CBN	H7	12	55	PX26d	13.2	58	1500	100/200	P.23
64210DWBRT ²⁾	(H7/H18)	12	19	PX26d/PY26d-1	-	-	-	-	P.13
64210DWESY ²⁾	(H7/H18)	12	16	PX26d/PY26d-1	-	-	-	-	P.12
64210DWINT ²⁾	(H7/H18)	12	16	PX26d/PY26d-1	-	-	-	-	P.13
64210ULT	H7	12	55	PX26d	13.2	58	1500	1000/1500	P.24
64211	H11	12	55	PGJ19-2	13.2	62	1350	350/580	P.25
64211DWBRT ²⁾	(H8/H11/H16/H9)	12	19	PGJ19-X	-	-	-	-	P.13
64211NB200	H11	12	55	PGJ19-2	13.2	62	1350	350/580	P.21
64211NL	H11	12	55	PGJ19-2	13.2	62	1350	150/250	P.22
64211NBS	H11	12	55	PGJ19-2	13.2	62	1350	250/450	P.23
64211CBN	H11	12	55	PGJ19-2	13.2	62	1350	100/200	P.23
64211ULT	H11	12	55	PGJ19-2	13.2	62	1350	1000/2000	P.24
64212	H8	12	35	PGJ19-1	13.2	43	800	400/800	P.25
64212NL	H8	12	35	PGJ19-1	13.2	max. 43	800	250/500	P.22
64212CBN	H8	12	35	PGJ19-1	13.2	43	800	250/500	P.23
64213	H9	12	65	PGJ19-5	13.2	73	2100	250/500	P.25
64215	H7	24	70	PX26d	28.0	75	1750	220/500	P.30
64215DWS ²⁾	(H7)	24	13/13	PX26d	-	-	-	-	P.16
64215TSP	H7	24	70	PX26d	28.0	75	1750	500/1000	P.29
64216TSP	H11	24	70	PGJ19-2	28.0	max. 80	1600	500/1000	P.29
64219L+	H16	12	19	PGJ19-3	13.2	26	500	1115/2000	P.26
64241	H11B	12	55	PGJY19-2	13.2	62	1350	350/580	P.25
64242	H8B	12	35	PGJY19-1	13.2	43	800	400/800	P.25
64243	H9B	12	65	PGJY19-5	13.2	73	2100	250/500	P.25
64326	S1	12	25/25	BA20d	13.5	25/25	430/310	-	P.32
64327	S2	12	35/35	BA20d	13.5	35/35	650/460	80/160	P.32
66140	D1S	85	35	PK32d-2	13.5	35	3200	2000/3000	P.20
66140XNN	D1S	85	35	PK32d-2	13.5	35	3200	1500/3000	P.18
66140CBN	D1S	85	35	PK32d-2	13.5	35	3200	1500/3000	P.19
66140ULT	D1S	85	35	PK32d-2	13.5	35	3200	-	P.19
66140CBB ²⁾	-	85	35	PK32d-2	13.2	35	3200	600/1500	P.34
66150	D1R	85	35	PK32d-3	13.5	35	2800	2000/3000	P.20
66150CBN	D1R	85	35	PK32d-3	13.5	35	2800	1500/3000	P.19
66240	D2S	85	35	P32d-2	13.5	35	3200	2000/3000	P.20
66240XNN	D2S	85	35	P32d-2	13.5	35	3200	1500/3000	P.18
66240CBN	D2S	85	35	P32d-2	13.5	35	3200	1800/2800	P.19
66240ULT	D2S	85	35	P32d-2	13.5	35	3200	-	P.19
66240CBB ²⁾	-	85	35	P32d-2	13.2	35	3200	600/1500	P.34
66250	D2R	85	35	P32d-3	13.5	35	2800	2000/3000	P.20
66250CBN	D2R	85	35	P32d-3	13.5	35	2800	1500/2000	P.19
66340	D3S	42	35	PK32d-5	13.5	35	3200	2000/4000	P.20
66340XNN	D3S	42	35	PK32d-5	13.5	35	3200	2000/3000	P.18
66340CBN	D3S	42	35	PK32d-5	13.5	35	3200	2000/3000	P.19
66340ULT	D3S	42	35	PK32d-5	13.5	35	3200	-	P.19

Product Reference	ECE	V	W		V _{Test}	W _{in}	lm	T _h E5/7c	1)
66340CBB ²⁾	-	85	35	PK32d-5	13.2	35	3200	-	P.34
66350	D3R	42	35	PK32d-6	13.5	35	2800	2000/3000	P.20
66440	D4S	42	35	P32d-5	13.5	35	3200	2000/4000	P.20
66440XNN	D4S	42	35	P32d-5	13.5	35	3200	2000/3000	P.18
66440CBN	D4S	42	35	P32d-5	13.5	35	3200	2000/3000	P.19
66440ULT	D4S	42	35	P32d-5	13.5	35	3200	-	P.19
66440CBB ²⁾	-	85	35	P32d-5	13.2	35	3200	-	P.34
66450	D4R	42	35	P32d-6	13.5	35	2800	2000/3000	P.20
66540	D5S	12	25	PK32d-7	13.2	25	2000	2500/4000	P.20
66548	D8S	42	25	PK32d-1	13.5	25	2000	2500/4000	P.20
66548CBN	D8S	42	25	PK32d-1	13.5	25	2000	-	P.19
67219CW	-	12	13	PGJ19	12	13	730	-	P.14
69005SBP ²⁾	-	12	100	P20d	13.2	100	2885	280/550	P.33
69006SBP ²⁾	-	12	80	P22d	13.2	max. 80	1890	600/1200	P.33
94196	H4	24	75/70	P43t	28.0	85/80	1900/1200	170/500//400/1500	P.30
LEDCAP01	-	12	-	-	-	-	-	-	P.11
LEDCAP02	-	12	-	-	-	-	-	-	P.11
LEDCAP03	-	12	-	-	-	-	-	-	P.11
LEDCAP04	-	12	-	-	-	-	-	-	P.11
LEDCAP06	-	12	-	-	-	-	-	-	P.11
LEDCAP07	-	12	-	-	-	-	-	-	P.11
LEDCBC101	-	12	5	-	-	-	-	-	P.16
LEDCBCTRL102	-	12	21	-	-	-	-	-	P.16
LEDDL ACC 101	-	12	-	-	-	-	-	-	P.45
LEDDL ACC 102	-	12	-	-	-	-	-	-	P.45
LEDDL ACC 103	-	12	-	-	-	-	-	-	P.45
LEDDL101-SP	-	12/24	22/2	-	13.5	22/2	1250	5000	P.46
LEDDL101-WD	-	12/24	22/2	-	13.5	22/2	1250	5000	P.46
LEDDL102-SP	-	12/24	30/2	-	13.5	30/2	2000	5000	P.45
LEDDL102-WD	-	12/24	30/2	-	13.5	30/2	2000	5000	P.46
LEDDL103-SP	-	12/24	35	-	13.2	35	2700	5000	P.44
LEDDL103-CB	-	12/24	35	-	13.2	35	2700	5000	P.44
LEDDL104-SP	-	12/24	36	-	13.2	36	4600	5000	P.44
LEDDL104-CB	-	12/24	68	-	13.2	36	4600	5000	P.44
LEDDL104-CB SM	-	12/24	68	-	13.2	36	4600	5000	P.44
LEDDL105-SP	-	12/24	14	-	13.2	14	1300	5000	P.45
LEDDL106-SP	-	12/24	29	-	13.2	29	2600	5000	P.45
LEDDL106-CB	-	12/24	29	-	13.2	29	2600	5000	P.45
LEDDL107-SP	-	12/24	46	-	13.2	46	3900	5000	P.45
LEDDL107-CB	-	12/24	44	-	13.2	46	3900	5000	P.45
LEDDL108-WD	-	12/24	15	-	13.2	15	1100	5000	P.45
LEDDL109-WD	-	12/24	15	-	13.2	15	1100	5000	P.45
LEDDL110-CB	-	12/24	45/1	-	13.2	49/1	2700	5000	P.45
LEDDL111-CB	-	12/24	39/1	-	13.2	39/1	3000	5000	P.45
LEDDL112-CB	-	12/24	60/2.5	-	13.2	60/2.5	3500	5000	P.45
LEDDL113-CB	-	12/24	70/1.5	-	13.2	70/1.5	4000	5000	P.45
LEDDL115-SP	-	12/24	27	-	13.2	27	1500	5000	P.45
LEDDL116-SP	-	12/24	63	-	13.2	63	2800	5000	P.45
LEDDL117-CB	-	12/24	30	-	13.2	30	2100	5000	P.45
LEDDL118-CB	-	12/24	55	-	13.2	55	4100	5000	P.45

Product Reference	ECE	V	W		V _{Test}	W _{In}	lm	T _h ¹⁾ E5/7c	
LEDDL119-WD	-	12/24	22	-	13.2	22	1150	5000	P.45
LEDDL120-CB SM	-	12/24	108	-	13.2	108	-	-	P.45
LEDDMI 5G0 WT S	-	12	2.4	-	13.2	2.4	-	5000	P.40
LEDDMI 5G0 BK S	-	12	2.4	-	13.2	2.4	-	5000	P.40
LEDDMI 5K0 WT S	-	12	2.4	-	13.2	2.4	-	5000	P.40
LEDDMI 5K0 BK S	-	12	2.4	-	13.2	2.4	-	5000	P.40
LEDDMI 3G0 WT S	-	12	2.4	-	13.2	2.4	-	5000	P.41
LEDDMI F20 WT S	-	12	4.56	-	13.2	4.56	-	5000	P.41
LEDDMI F20 BK S	-	12	4.56	-	13.2	4.56	-	5000	P.41
LEDDMI 5F0 WT S	-	12	2.4	-	13.2	2.4	-	5000	P.41
LEDDMI 5F0 BK S	-	12	2.4	-	13.2	2.4	-	5000	P.41
LEDDMI 8W0 WT S	-	12	2.4	-	13.2	2.4	-	5000	P.42
LEDDMI 8W0 BK S	-	12	2.4	-	13.2	2.4	-	5000	P.42
LEDDMI 8V0 WT S	-	12	2.4	-	13.2	2.4	-	5000	P.42
LEDDMI 8V0 BK S	-	12	2.4	-	13.2	2.4	-	5000	P.42
LEDDRL102	-	12	15	-	14.0	15	300	5000	P.47
LEDDRL301CL15	-	12	13.5	-	14.0	13.5	300	5000	P.47
LEDEC01-2HFB	-	12	-	-	-	-	-	-	P.11
LEDHL102-BK	-	12	70	-	-	-	-	-	P.38
LEDHL102-BK RHD	-	12	70	-	-	-	-	-	P.38
LEDHL102-CM	-	12	70	-	-	-	-	-	P.38
LEDHL102-GTI	-	12	70	-	-	-	-	-	P.38
LEDHL103-GTI	-	12	70	-	-	-	-	-	P.35
LEDHL103-BK	-	12	70	-	-	-	-	-	P.35
LEDHL103-CM	-	12	70	-	-	-	-	-	P.35
LEDHL103-CM RHD	-	12	70	-	-	-	-	-	P.35
LEDHL104-GTI	-	12	-	-	-	-	-	-	P.36
LEDHL104-BK	-	12	-	-	-	-	-	-	P.36
LEDHL104-CM	-	12	-	-	-	-	-	-	P.36
LEDHL105	-	12	70	-	-	-	-	-	P.37
LEDHL107-BK	-	12	-	-	-	-	-	-	P.36
LEDHL107-BK RHD	-	12	-	-	-	-	-	-	P.36
LEDHL108-BK	-	12	-	-	-	-	-	-	P.37
LEDHL108-CM	-	12	-	-	-	-	-	-	P.37
LEDHL109-BK	-	12	-	-	-	-	-	-	P.36
LEDHL109-GTI	-	12	-	-	-	-	-	-	P.36
LEDUHL101	-	12/24	34	-	-	-	-	-	P.39
LEDUHL102	-	12/24	34	-	-	-	-	-	P.39
LEDUHL103	-	12/24	28	-	-	-	-	-	P.39
LEDUHL104	-	12/24	28	-	-	-	-	-	P.39
LEDUHL MOUNT101-	-	-	-	-	-	-	-	-	P.39
LEDINT201 ²⁾	-	12	-	-	-	-	-	-	P.48
LEDINT201-SEC ²⁾	-	12	-	-	-	-	-	-	P.48
LEDINT202 ²⁾	-	12	-	-	-	-	-	-	P.48
LEDINT203 ²⁾	-	12	-	-	-	-	-	-	P.48
LEDPWL 101-UW	-	12/24	27	-	-	-	-	-	P.46
LEDPWL 102-UW	-	12/24	33	-	-	-	-	-	P.46
LEDPWL 103-UW	-	12/24	45	-	-	-	-	-	P.46
LEDPWL 104-WD	-	12/24	27	-	-	-	-	-	P.46
LEDPWL 105-WD	-	12/24	33	-	-	-	-	-	P.46

Product Reference	ECE	V	W		V _{Test}	W _{th}	Im	T[h] B3/Tc 1)	
LEDPWL 106-WD	-	12/24	45	-	-	-	-	-	P.46
LEDPWL 107-FL	-	12/24	27	-	-	-	-	-	P.46
LEDPWL 108-FL	-	12/24	33	-	-	-	-	-	P.46
LEDPWL 109-FL	-	12/24	45	-	-	-	-	-	P.46
LEDPWL 110-SP	-	12/24	27	-	-	-	-	-	P.46
LEDPWL 111-SP	-	12/24	33	-	-	-	-	-	P.46
LEDPWL 112-SP	-	12/24	45	-	-	-	-	-	P.46
LEDPWL 113-UW	-	12/24	15	-	-	-	-	-	P.46
LEDPWL 114-WD	-	12/24	15	-	-	-	-	-	P.46
LEDPWL 115-FL	-	12/24	15	-	-	-	-	-	P.46
LEDPWL 116-SP	-	12/24	15	-	-	-	-	-	P.46
LEDPWL ACC 101	-	12	-	-	-	-	-	-	P.45
LEDPWL ACC 102	-	12	-	-	-	-	-	-	P.45
LEDPWL ACC 103	-	12	-	-	-	-	-	-	P.45
LEDSC01-2HFB	-	12	-	-	-	-	-	-	P.16
LEDSC01-2HFB	-	12	-	-	-	-	-	-	P.24
LEDSC02-1-2HFB	-	12	-	-	-	-	-	-	P.24
LEDSC03-2HFB	-	12	-	-	-	-	-	-	P.24
LEDSC03-1-2HFB	-	12	-	-	-	-	-	-	P.24
LEDTL101-CL	-	12	27	-	-	-	-	-	P.43
LEDTL102-CL	-	12	30	-	-	-	-	-	P.43
LEDWL101-SP	-	12/24	8	-	-	-	-	-	P.46
LEDWL102-SP	-	12/24	8	-	-	-	-	-	P.46
LEDWL103-WD	-	12/24	8	-	-	-	-	-	P.46

1) What do B3 and Tc mean in connection with the service life of bulbs? If we consider the service lives of products that are designed to last a certain time, we can see that they all have identical or similar failure characteristics. If we plot the service lives of the individual bulbs on special logarithmic graph paper, the graph produced is called a “Weibull distribution curve”. In a stable production process, we obtain a straight line for the service life via which we can read off various life values. For its products in the automotive sector, OSRAM specifies a B3 value, which indicates the time at which 3% of the tested bulbs have failed. OSRAM also specifies the Tc value (characteristic Weibull value), which indicates the time at which 63.2% of the bulbs have failed. Formerly, only the average value was specified (the average life), which in this system would correspond to a B50 value (i.e. the time at which 50% of the bulbs have failed). By specifying both the B3 value and the Tc value it is possible to get an idea of the spread of the product’s service life and hence the quality of the product.

Explanation: single filament lamp e.g. 100/300 | dual filament lamp e.g. $\underbrace{100/300}_{B_3} / \underbrace{500/100}_{T_c}$

2) These products do not have ECE approval and must not be used on public roads in any exterior application. Public roads use leads to cancellation of operating license and loss of insurance coverage. Several countries forbid sale and use of these products. Please contact your local distributor for further information.

Regional EAN overview

The new packaging reflects specific regional requirements by offering regionalized variants with a dedicated EAN.

■ Region 4 = LATAM ■ Region 5 = EMEA

COUNTRY	REGION LED + VAP Blister, DUO BOX	REGION ORIGINAL Blister	COUNTRY	REGION LED + VAP blister, DUO BOX	REGION ORIGINAL Blister	COUNTRY	REGION LED + VAP blister, DUO BOX	REGION ORIGINAL Blister	COUNTRY	REGION LED + VAP blister, DUO BOX	REGION ORIGINAL Blister
Albania		■	Denmark		■	Kosovo		■	Saint Lucia	■	
Algeria		■	Dominica	■		Kuwait		■	Saint Vincenta and the Grenadines	■	
Angola		■	Dominican Republic	■		Latvia		■	Saudi Arabia		■
Antigua and Barbuda	■		Grenada	■		Lebanon		■	Serbia		■
Argentina	■		Georgia		■	Libya		■	Slovakia		■
Armenia		■	Germany		■	Lithuania		■	Slovenia		■
Austria		■	Greece		■	Macedonia		■	South Africa		■
Azerbaijan		■	Guatemala	■		Morocco		■	Spain		■
Bahamas	■		Guyana	■		Mexico	■		Suriname	■	
Bahrain		■	Haiti	■		Moldavia		■	Sweden		■
Barbados	■		Honduras	■		Monte Negro		■	Switzerland		■
Belarus		■	Ecuador	■		Mosambique		■	Syria		■
Belize	■		El Salvador	■		Namibia		■	Tanzania		■
Benelux (Belgium, Netherlands, Luxembourg)		■	Egypt		■	Nicaragua	■		Trinidad and Tobago	■	
Bolivia	■		Estonia		■	Nigeria		■	Tunisia		■
Bosnia and Herzegovina		■	Ethiopia		■	Norway		■	Turkey		■
Botswana		■	Finland		■	Oman		■	UK/Ireland		■
Brazil	■		France		■	Pakistan		■	Ukraine		■
Bulgaria		■	Hungary		■	Palestine		■	United Arab Emirates		■
Chile	■		Iran		■	Panama	■		Uruguay	■	
Colombia	■		Iraq		■	Paraguay	■		Uzbekistan/ Turkmenistan		■
Costa Rica	■		Israel		■	Peru	■		Venezuela	■	
Croatia		■	Italy		■	Poland		■	Yemen		■
Czechia		■	Jamaica	■		Portugal		■	Zimbabwe		■
Cuba	■		Jordan		■	Qatar		■			
			Kazakhstan/ Kirgistan		■	Romania		■			
			Kenya		■	Russia		■			
						Saint Kitts and Nevis	■				

Product Reference

■ Region 4 = LATAM

■ Region 5 = EMEA

7506-02B	4052899402034	4050300925448
7507-02B	4052899531178	4050300925462
7225-02B	4052899402119	4050300925547
7528-02B	4052899402171	4050300925523
3893-02B	4052899407381	4050300647609
2821-02B	4052899418813	4050300925745
2825-02B	4052899418837	4050300925684
2827NA-02B	4052899570870	4052899570894
921-02B	4052899406933	4008321349507
7505-02B	4052899417878	4052899324565
7515-02B	4052899417892	4052899324589

Product Reference	■ Region 4 = LATAM	■ Region 5 = EMEA
2721-02B	4052899418790	4050300925769
2722-02B	4052899407251	4050300925783
5007-02B	4052899407015	4050300925585
5008-02B	4052899407176	4050300925608
6411-02B	4052899418936	4050300925646
64111-02B	-	4050300647258
6418-02B	4052899418950	4050300925622
6438-02B	-	4008321185389

LEDiving® lamps

Overview of LED forward lighting applications



LEDiving® replacement lamps – Exterior front lighting ¹⁾						
1	2	3	4	5	6	
Low beam / High beam ²⁾	Daytime running light	Fog light	Front indicator	Parking/ marker light / Position light	Side indicator	
≅ H1, H4/H19, H7/H18, H8/ H11/H16/H9, HB3/H10/HR1, HB4/HR2, H13, H15	≅ H7, H8/H11/H16, PS13W, PS19W, P21W, P21/5W, P27/7W, W16W, W21W, W21/5W	≅ H8/H11/H16, H10	≅ P21W, P21/5W, PY21W, P27W, P27/7W, W21W	≅ P21/5W, P27/7W, W5W, W21W, W21/5W	≅ P21W, WY5W	
P14.5s	PX26d/PY26d-1	PGJ19	BA15s	BAY15d	BA15s	
P43t/PU43t-3	PGJ19	PY20d	BAY15d	W2.5x16q	W2.1x9.5d	
PX26d/PY26d-1	PG18.5d-1	PSX24W	BAU15s	W2.1x9.5d		
PGJ19-X	PG20-1	PX26d/PY26d-1	W2.5x16q	W3x16d		
P20d /PY20d/PX20d	BA15s	PGJ19-X	W3x16d	W3x16q		
P22d/PX22d	BAY15d	P20d /PY20d/PX20d				
P26.4t	W2.5x16q	P22d/PX22d				
PGJ23t-1	W2.1x9.5d					
	W3x16d					
	W3x16q					
Smart Canbus ³⁾		Canbus Control Unit 21 W ⁴⁾		Canbus Control Unit 5 W ⁴⁾		

LED Color	Use behind red glass	Use behind clear glass	Use behind amber glass
Red (Tail light, Brake light)	Yes	Not recommended	Not recommended
Cool White (Daytime running light, Reversing light, License plate light, Parking light)	Not recommended	Yes	Not recommended
Amber (Indicator light, Side marker light)	Not recommended	Yes	Yes

LEDDriving® lamps

Overview of LED rear lighting applications



LEDDriving® replacement lamps – Exterior rear lighting ¹⁾										
1	2	3	4	5	6	7				
Rear indicator	License plate light	Brake light, Third braking light	Rear fog light	Tail light	Reversing light	Additional brake light				
≅ P21W, PY21W, P27/7W, W21W	≅ C5W, R5W, R10W, T5/W2.3W, P21W, P21/5W, W5W	≅ P21W, P21/5W, P27/7W, W5W, W21W, W21/5W	≅ P21W, P21/5W, P27/7W, W16W, W21W	≅ P21W, P21/5W, P27/7W, R5W, R10W, T5/W2.3W, W5W, W21W, W21/5W	≅ P21W, P27/7W, W16W, W21W	≅ P21W, P21/5W, P27/7W, W5W, W21W, W21/5W				
BA15s	SV8.5-8 (31, 36, 41mm)	BA15s	BA15s	BA15s	BA15s	BA15s	BA15s	BA15s	BA15s	BA15s
BAU15s	BA15s	BAY15d	BAY15d	BAY15d	BAY15d	W2.5x16q	BAY15d	BAY15d	BAY15d	BAY15d
W2.5x16q	BA15s	W2.5x16q	W2.5x16q	W2.5x16q	W2.5x16q	W2.1x9.5d	W2.5x16q	W2.5x16q	W2.5x16q	W2.5x16q
W3x16d	W2x4.6d	W2.1x9.5d	W2.1x9.5d	W2.1x9.5d	BA15s	W3x16d	W2.1x9.5d	W3x16d	W2.1x9.5d	W2.1x9.5d
	BA15s	W3x16d	W3x16d	W3x16d	BA15s		W3x16d	W3x16d	W3x16d	W3x16d
	BAY15d	W3x16q			W2x4.6d		W3x16q		W3x16q	W3x16q
	W2.1x9.5d				W2.1x9.5d					
					W3x16d					
					W3x16q					
Canbus Control Unit 21W ⁴⁾ 				Canbus Control Unit 5W and 21W ⁴⁾ 						

Available color options:

LEDDriving® SL

 Cool White
  Red

 Amber

1) These products do not have ECE approval and must not be used on public roads in any exterior application. Public roads use leads to cancellation of operating license and loss of insurance coverage. Several countries forbid sale and use of these products. Please contact your local distributor for further information. | 2) Please refer to page 12 ff. for details | 3) LEDDriving® SMART CANBUS avoids error messages on the board computer when using LED lamps | 4) LEDDriving® CANBUS CONTROL UNIT (P.16) avoids error messages on the board computer when using LED lamps within 5 W or 21 W applications

LEDDriving® Interior Lamps – Overview of LED interior lighting applications



LEDDriving® replacement lamps – Interior lighting ¹⁾									
1	2	3	4	5	6	7	8	9	10
Dome light front	Reading light front	Dome light behind	Reading light behind	Glovebox light	Trunk light	Legroom light	Door/Side light	Engine compartment light	Make-up mirror/visor light
≅ W5W, C5W, T4W, R5W, R10W, T5/W2.3W				≅ W5W, WY5W, C5W, T4W, R5W, R10W, T5/W2.3W		≅ W5W, WY5W, C5W, T4W, R5W, R10W, T5/W2.3W			≅ W5W, C5W, T4W, R5W, R10W, T5/W2.3W
W2.1x9.5d	W2.1x9.5d	W2.1x9.5d	W2.1x9.5d	W2.1x9.5d	W2.1x9.5d	W2.1x9.5d	W2.1x9.5d	W2.1x9.5d	W2.1x9.5d
SV8.5-8 (31, 36, 41mm)	SV8.5-8 (31, 36, 41mm)	SV8.5-8 (31, 36, 41mm)	SV8.5-8 (31, 36, 41mm)	SV8.5-8 (31, 36, 41mm)	SV8.5-8 (31, 36, 41mm)	SV8.5-8 (31, 36, 41mm)	SV8.5-8 (31, 36, 41mm)	SV8.5-8 (31, 36, 41mm)	SV8.5-8 (31, 36, 41mm)
BA9s	BA9s	BA9s	BA9s	BA9s	BA9s	BA9s	BA9s	BA9s	BA9s
BA15s	BA15s	BA15s	BA15s	BA15s	BA15s	BA15s	BA15s	BA15s	BA15s
BA15s	BA15s	BA15s	BA15s	BA15s	BA15s	BA15s	BA15s	BA15s	BA15s
W2x4.6d	W2x4.6d	W2x4.6d	W2x4.6d	W2x4.6d	W2x4.6d	W2x4.6d	W2x4.6d	W2x4.6d	W2x4.6d
Canbus Control Unit 5W 									

Available color options:

LEDDriving® SL

-  Cool White
-  Red
-  Amber

1) These products do not have ECE approval and must not be used on public roads in any exterior application. Public roads use leads to cancellation of operating license and loss of insurance coverage. Several countries forbid sale and use of these products. Please contact your local distributor for further information.

Dome light front 

ECE/SAE:	C5W ●	T4W ●	W5W ●●
Reference No.:	6418	3893	2825
			

Glovebox 

ECE/SAE:	C5W ●	R5W ●	T4W ●	W2.3W	W3W	W5W ●●
Reference No.:	6418	5007	3893	2723	2821	2825
						

Engine compartment light 

ECE/SAE:	C5W ●	P21W ●	R10W ●	W5W ●●
Reference No.:	6418	7506	5008	2825
				

Legroom 

ECE/SAE:	C5W ●	W3W	W5W ●●
Reference No.:	6418	2821	2825
			

Reading lamp front 

ECE/SAE:	C5W ●	H6W ●	R5W ●	R10W ●	T4W ●	W5W ●●
Reference No.:	6418	64132	5007	5008	3893	2825
						

Make-up mirror 

ECE/SAE:	C5W ●	W5W ●●
Reference No.:	6418	2825
		

Door lamp 

ECE/SAE:	C5W ●	R5W ●	W3W	W5W ●●
Reference No.:	6418	5007	2821	2825
				

Dome light behind 

ECE/SAE:	C5W ●	H6W ●	R5W ●	R10W ●	T4W ●	W5W ●●
Reference No.:	6418	64132	5007	5008	3893	2825
						

Trunk lamp 

ECE/SAE:	C5W ●	P21W ●	R5W ●	R10W ●
Reference No.:	6418	7506	5007	5008
				
	T4W ●	W3W	W5W ●●	
	3893	2821	2825	
				

Reading lamp behind 

ECE/SAE:	C5W ●	T4W ●	W5W ●●
Reference No.:	6418	3893	2825
			

Recommend a light upgrade for more sight and road safety

Upgrade halogen/auxiliary lighting

- COOL BLUE® INTENSE (NEXT GEN) (p.23)
- ULTRA LIFE (p.24)

Low beam / High beam 

ECE/SAE:	H1	H3	H4	LED H4	H7	LED H7	H8	H9	
Reference No.:	64150	64151	64193	64193DWNB ¹⁾	64210	64210DWNB ¹⁾	64212	64213	
									
	H9B 64243	H11 64211	H11B 64241	H13 9008	H15 64176	H18 64180L	H19 64181L	HB3 9005	HB3A 9005XS
									
	HB4 9006	HB4A 9006XS	HB5 9007	HIR1 9011	HIR2 9012	H27W/1 880	R2 64183	D1S 66140	
									
	D1R 66150	D2S 6240	D2R 66250	D3S 66340	D3R 66350	D4S 66440	D4R 66450	D8S 66548	
									

Fog light 

ECE/SAE:	H1	H3	H7	
Reference No.:	64150	64151	64210	
				
	H8 64212	H8B 64242	H10 9145	H11 64211
				
	H11B 64241	H16 64219L+	H27W/1 880	H27W/2 881
				
	HB3 9005	HB3A 9005XS	HB4 9006	HB4A 9006XS
				
	H21W 64136	PSX24W 2504		
				

License plate light 

ECE/SAE:	C5W	R5W	R10W	T4W	W3W	W5W
Reference No.:	6418	5007	5008	3893	2821	2825
						

Front indicator 

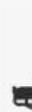
ECE/SAE:	H21W	HY21W	P21W	PY21W	P27W	PS19W	PS24W	W21W	WY21W	WT21W	WTY21W
Reference No.:	64136	64137ULT	7506	7507	3156	5201	5202	7505	7504	7805	7804
											

Daytime running light 

ECE/SAE:	H7	H8	H15	H21W	P21W
Reference No.:	64210	64212	64176	64136	7506
					
	P21/5W 7528	P27/7W 3157	PS19W 5201	PS24W 5202	W16W 921
					
	W21W 7505	W21/5W 7515	WT21W 7805	WT21/7W 7815	
					

Parking / marker light 

ECE/SAE:	H8	H15	H6W	P21/5W	P27/7W	PS19W
Reference No.:	64212	64176	64132	7528	3157	5201
						
	PS24W 5202	P13W 828	PSX26W 6851	R5W 5007	R10W 5008	T4W 3893
						
	W3W 2821	W5W 2825	W21W 7505	W21/5W 7515	WT21W 7805	WT21/7W 7815
						



Brake light / Third braking light  

ECE/SAE: Reference No.:	H21W 64136	P21W ● 7506	P21/4W 7225	P21/5W ● 7528	P27W 3156	P27/7W 3157	PS19W 5201
							
	PS24W 5202	PSX26W 6851	R5W ● 5007	R10W ● 5008	W2.3W 2723	W3W 2821	W5W ●● 2825
							
	W16W 921	W21W 7505	W21/5W 7515	WT21W 7805	WT21/7W 7815		
							

Recommend a light upgrade for more sight and road safety

Upgrade halogen/auxiliary lighting

- NIGHT BREAKER® 200 (p.21)
- NIGHT BREAKER® LASER (p.22)
- NIGHT BREAKER® SILVER (p.22)
- COOL BLUE® INTENS (NEXT GEN) (p.23)
- DIADEM® CHROME (p.24)
- ULTRA LIFE (p.24)

Upgrade xenon lighting

- XENARC® NIGHT BREAKER® LASER (NEXT GEN) (p.18)
- XENARC® COOL BLUE® INTENSE (NEXT GEN) (p.19)
- XENARC® ULTRA LIFE (p.19)

Upgrade LED lighting

- NIGHT BREAKER® H4 LED (p.10)
- NIGHT BREAKER® H7 LED (p.10)

Tail light 

ECE/SAE: Reference No.:	P21W ● 7506	P21/4W 7225	P21/5W ● 7528	P27/7W 3157	R5W ● 5007
					
	R10W ● 5008	T4W ● 3893	W3W 2821	W5W ●● 2825	W16W 921
					
	W21W 7505	W21/5W 7515	WT21W 7805	WT21/7W 7815	
					

Rear indicator 

ECE/SAE: Reference No.:	H6W 64132	H21W 64136	HY21W ● 64137ULT	P21W ● 7506
				
	PY21W ●● 7507	P27W 3156	PS19W 5201	PSX26W 6851
				
	PS24W 5202	R10W ● 5008	RY10W 5009	W16W 921
				
	WY16W 921NA	W21W 7505	WY21W 7504	
				

Side indicator 

ECE/SAE: Reference No.:	T4W 3893	W3W 2821	W5W ●● 2825	WY5W ● 2827NA
				

Reversing light 

ECE/SAE: Reference No.:	H21W 64136	P21W ● 7506	P27W 3156	PS19W 5201	PS24W 5202	W16W 921	W21W 7505	WT21W 7805
								

Rear fog light 

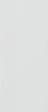
ECE/SAE: Reference No.:	H21W 64136	P21W ● 7506	P21/4W 7225	P21/5W ● 7528	P27W 3156	P27/7W 3157	W16W 921	W21W 7505	W21/5W 7515	WT21W 7805	WT21/7W 7815
											



1) Approved LED headlamp. Only applies to the respective countries in which there is approval and the vehicle models and light functions currently listed in the compatibility list. For exact conditions see www.osram.com/nb-led

Recommend a light upgrade for more sight and road safety

Upgrade halogen/auxiliary lighting

● TRUCKSTAR® PRO (p.29)

Upgrade xenon lighting

● XENARC® NIGHT BREAKER® LASER (p.18) (NEXT GEN)

● XENARC® COOL BLUE® INTENSE (NEXT GEN) (p.19)

● XENARC® ULTRA LIFE (p.19)

Upgrade LED lighting

● NIGHT BREAKER® H7 LED (p.10)

Low beam / High beam



ECE/SAE: H1 ● H3 ● H4 ● H7 ● LED H7 ● H11 ● H15
Reference No.: 64155 64156 64196 64215 64210DWNB¹⁾ 64216TSP 64177



D1S ●●● D1R ●●● D2S ●●● D2R ●●● D3S ●●●
66140 66150 66240 66250 66340



D3R ●●● D4S ●●● D4R ●●● D8S ●●●
66350 66440 66450 66548



Daytime running light



ECE/SAE: H2 ● H15 ● H21W ● P21W ●
Reference No.: 64175 64177 64138 7511



Side indicator



ECE/SAE: H21W ● P21W ● P21/5W ● PY21W ●
Reference No.: 64138 7511 7537 7510TSP



R5W ● T4W ● W5W ●
5627 3930 2845



Front indicator



ECE/SAE: H21W ● P21W ● P21/5W ● PY21W ●
Reference No.: 64138 7511 7537 7510TSP



Fog light



ECE/SAE: H1 ● H2 ● H3 ●
Reference No.: 64155 64175 64156



H4 ● H7 ● H11 ●
64196 64215 64216TSP



Parking/marker light / Side-marker light



ECE/SAE: C5W ● P21W ● P21/5W ● R5W ●
Reference No.: 6423 7511 7537 5627



R10W ● T4W ● W3W ● W5W ●
5637 3930 2841 2845



Parking/marker light



ECE/SAE: R5W ● R10W ● T4W ● W3W ● W5W ●
Reference No.: 5627 5637 3930 2841 2845



License plate light



ECE/SAE: C5W ● R5W ● R10W ● W5W ●
Reference No.: 6423 5627 5637 2845



Indicator/brake/rear fog/tail and reversing light



ECE/SAE: P21W ● P21/5W ● PY21W ● R5W ● R10W ● W5W ●
Reference No.: 7511 7537 7510TSP 5627 5637 2845



Low beam / High beam / Fog light 

ECE/SAE:	H1 ●●●●●	H3 ●	H4 ●●●●●	H7 ●●●●●	H8 ●●●●●	H11 ●●●●●
Reference No.:	64150	64151	64193	64210	64212	64211
						
HS1	HB3 ●●	HB4 ●●	HIR2 ●	S1	S2	R2
64185	9005	9006	9012	64326	64327	64183
						
D1S ●●●	D1R ●●●	D2S ●●●				
66140	66150	6240				
						

Recommend a light upgrade for more sight and road safety

Upgrade halogen/auxiliary lighting

- NIGHT BREAKER® 200 (p.21)
- NIGHT BREAKER® LASER (p.22)
- NIGHT BREAKER® SILVER (p.23)
- COOL BLUE® INTENSE (NEXT GEN) (p.23)
- DIADEM® CHROME (p.24)
- ULTRA LIFE (p.24)

Upgrade xenon lighting

- XENARC® NIGHT BREAKER® LASER (NEXT GEN) (p.18)
- XENARC® COOL BLUE® INTENSE (NEXT GEN) (p.19)
- XENARC® ULTRA LIFE (p.19)



Reversing/brake/rear fog light 

ECE/SAE:	P21W ●	P21/5W ●	P27/7W ●	R5W ●	
Reference No.:	7506	7528	3157	5007	
					
	R10W ●	T4W ●	W5W ●●		
	5008	3893	2825		
					
	WY5W ●	W16W ●	W21/5W ●		
	2827NA	921	7515		
					

Front indicator / Parking/marker light 

ECE/SAE:	H6W ●	H21W ●	P21W ●	P21/5W ●
Reference No.:	64132	64136	7506	7528
				
	PY21W ●	R5W ●	R10W ●	RY10W ●
	7507	5007	5008	5009
				
	T4W ●	W3W ●	W5W ●●	WY5W ●
	3893	2821	2825	2827NA
				
	W16W ●	W21W ●	W21/5W ●	WY21W ●
	921	7505	7515	7504
				



Rear indicator 

ECE/SAE:	H6W ●	P21W ●	P21/5W ●
Reference No.:	64132	7506	7528
			
	PY21W ●	R10W ●	RY10W ●
	7507	5008	5009
			
	W5W ●●	WY5W ●	W16W ●
	2825	2827NA	921
			
	WY16W ●	W21W ●	WY21W ●
	921NA	7505	7504
			

License plate light 

ECE/SAE:	C5W ●	H6W ●	P21W ●	P21/5W ●	R5W ●	R10W ●	T4W ●	W3W ●	W5W ●●
Reference No.:	6418	64132	7506	7528	5007	5008	3893	2821	2825
									

1) Approved LED headlamp. Only applies to the respective countries in which there is approval and the vehicle models and light functions currently listed in the compatibility list. For exact conditions see www.osram.com/nb-led

Base stamp

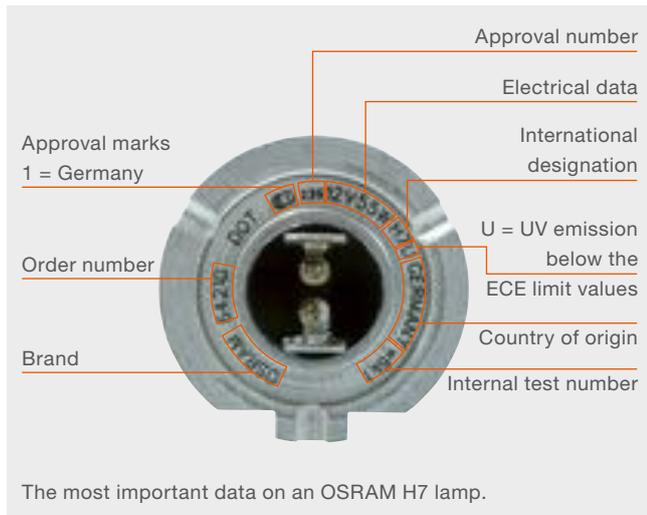

Notes on product labeling

	Not for residential lighting		Do not dispose with household waste
	High levels of UV radiation		Switch off lights before replacing lamp
	Installation and maintenance only by qualified electricians		Ignition procedure for lamps with external igniter
	Caution: Hot		Lamp cannot be dimmed
	Hazardous voltage		Wear suitable gloves when fitting or removing
	Do not use the lamp if the glass bulb is scratched or damaged		Protect against splashes
	Wear suitable goggles when fitting or removing		Operate only in shielded luminaires
	Do not touch the glass bulb; hold the base when inserting		Pb-free

Symbols

	Int. category label ECE
	Rated wattage in watts
	Power consumption in watts
	Voltage in volts
	Test voltage in volts
	Luminous flux in lumens
	Lifespan (h)
	Illuminance in lux
	Wavelength (λ)
	Color temperature in K
	Light color
	Information
	Base
	Fig. no.
	Set
	Width b in mm
	Height h in mm
	Length l in mm
	Shipping unit
	Single packaging

Any manipulation of our products or packaging, including but not limited to modification, reworking or restamping, is prohibited and infringes our registered trademark rights. Such modifications may impair the technical properties of our products, destroy them or cause consequential damage or injury, for which OSRAM cannot under any circumstances be held responsible. For more information on our products, go to: www.osram.com

Glossary of the most important lighting terms

Luminous flux Φ

Unit of measurement: lumen [lm]

Luminous flux Φ is the total radiated power emitted by a light source evaluated with the spectral sensitivity of the eye and the photometric radiation equivalent K_m .

Luminous flux Φ is the luminous intensity I emitted in the entire solid angle Ω .

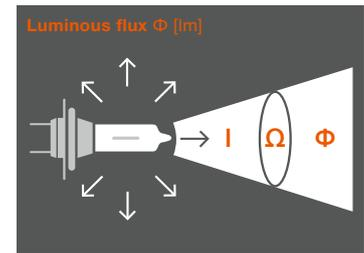

Luminous intensity I

Unit of measurement: candela [cd]

Generally speaking, a light source emits its luminous flux Φ in different directions and at different intensities.

Luminous intensity is the luminous flux radiated in a specific direction (solid angle Ω).

Polar diagram.

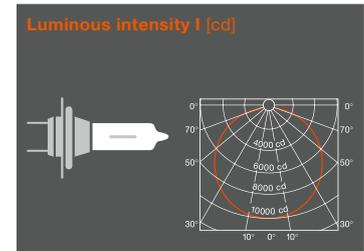

Illuminance E

Unit of measurement: lux [lx]

Illuminance E is the ratio between the luminous flux and the area illuminated. An illuminance of 1 lx occurs when a luminous flux of 1 lm is evenly distributed over an area of 1 m².

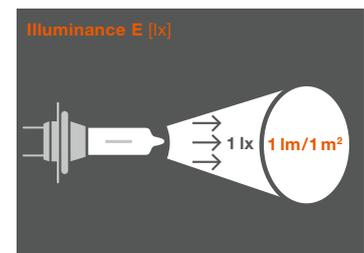

Luminance L

Unit of measurement: candela per square meter [cd/m²]

The luminance L of a light source or an illuminated area is a measure of the impression of brightness.

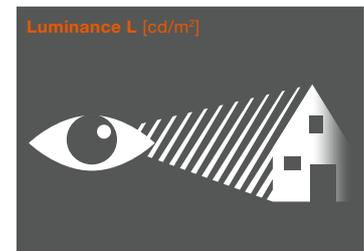

Luminous efficacy η

Unit of measurement: lumens per watt [lm/W]

Luminous efficacy η indicates the efficiency with which the electrical power consumed is converted into light.

Color temperature

Unit of measurement: Kelvin [K]

The color temperature of a light source is defined in comparison with a "black body radiator" and plotted on what is known as the "Planckian curve." The higher the temperature of this black body radiator is, the greater the blue component in the spectrum and the smaller the red component.

Lamp life

The B_3 life-span value represents the premature failure rate of lamps. This means that 3% of all tested lamps will have failed after this number of burning hours.

The T_c lifespan value represents the failure rate of 63.2% of the lamps.

Light range 2022/2023 – always up-to-date

Download the pdf of our current catalog that's constantly updated. www.osram.com/am-catalog-digital



Stay up to date!

Follow OSRAM Automotive on Facebook:

www.facebook.com/osramautomotive



Which lamps fit your vehicle?

Find out with our Vehicle Lamp Finder online app:

www.osram.com/vehicelamps



Get inspired and take your car to the next level!

Follow us on Instagram:

www.instagram.com/osram.automotive



Installation tutorials, product videos and more!

Follow our YouTube channel:

www.youtube.com/OSRAMAutomotive



OSRAM GmbH

Head office:

Marcel-Breuer-Strasse 6
80807 Munich, Germany
Phone +49 89 6213-0
Fax +49 89 6213-2020
www.osram.com

OSRAM